



**TEMPERATURE
CALIBRATOR
TC-512-HP**

TECHNICAL MANUAL

IMPORTANT INSTRUCTIONS:

- Keep the calibrator in a dry environment whenever possible.
- The fuse for the protection of the current measurement circuit, code 01.02.0277-21, is a special part. So, only replace the fuse by another original from factory.
- In case of failure, always send the instrument to the factory for repair.
- When not in daily use, before starting up, leave the calibrator turned on for at least one hour.

Table of Contents

1 - Introduction	1
1.1. General Description	1
1.2. Specifications - Inputs.....	2
1.3. Specifications - Outputs.....	5
2 - Operation	9
2.1. Parts Identification	9
2.2. Battery and charger	12
2.3. Using the Calibrator: basic functions	12
2.4. Measurement or input functions	15
2.5. Generation or output functions	22
2.6. Available power supplies	26
2.7. Calibration examples	27
2.8. Special Programming	30
2.8.1. FILTER Programming	30
2.8.2. DECIMAL Programming.....	30

2.8.3. STEP Programming	31
2.8.4. RAMP Programming	32
2.9. Special Functions	33
2.9.1. SCALE Function.....	34
2.9.2. CAL Function	36
2.9.3. SCALE Function.....	38
2.9.4. CONV Function	40
2.10. MEM Command.....	41
2.11. Warning Messages	42
3 - Adjustment	43
3.1. Input adjustment (IN)	44
3.2. Output adjustment (OUT)	46
4 - Maintenance.....	50
4.1. Battery pack replacement	50
4.2. Input current fuse substitution.....	51
Notes	52

1 - Introduction

1.1. General Description

The TC-512-HP High Precision Temperature Calibrator enables measurement and generation of signals used on instrumentation and process control. Provides all features required for easier calibration and adjustment services on process instruments. It is a high-accuracy instrument, having high stability features in temperature changes and long-term aging conditions. Designed for on-field operation, contains useful items as carrying case holders with fastener rings or belts for a hands-free operation. A high contrast liquid crystal display for a better viewing in poor lighting conditions, rechargeable battery included and a large-size memory intended to store values obtained for a later upload to computer, when applicable. Various constructive features aggregate quality and efficiency to the calibrator, allowing its on-field and workbench use.

Incorporates state-of-the-art concepts of automatic calibration and adjustment via computer. Instrument and computer share measurement data obtained for a more efficient handling of information such as report and certificate issues, automatic work management, data sorting and storage, for an overall coverage of quality procedure requirements, specially those related to ISO-9000.

Additionally, various optional modules are available, intended to perform temperature measurements acting as a standard thermometer when provided with a high accuracy certified sensor, informing on the actual temperature and a measurement indication from another sensor under certification simultaneously, storing all data collected.

1.2. Specifications - Inputs

	Input Ranges	Resolution	Accuracy	Remarks
millivolt	-150 mV to 150 mV	0.0001 mV	$\pm 0.005\%$ FS	$R_{\text{input}} > 10\text{ M}\Omega$ auto-ranging
	-500 mV to -150 mV	0.001 mV	$\pm 0.01\%$ FS	
	150 mV to 2450 mV	0.001 mV	$\pm 0.01\%$ FS	
volt	-10 V to 11 V	0.0001 V	$\pm 0.02\%$ FS	$R_{\text{input}} > 1\text{ M}\Omega$
	11 V to 45 V	0.0001 V	$\pm 0.02\%$ FS	
mA	-5 mA to 24.5 mA	0.0001 mA	$\pm 0.02\%$ FS	$R_{\text{input}} < 160\ \Omega$
resistance	0 to 400 Ω	0.01 Ω	$\pm 0.01\%$ FS	Excitation current 0.85 mA, auto-ranging
	400 to 2500 Ω	0.01 Ω	$\pm 0.03\%$ FS	
Pt-100	-200 to 850 $^{\circ}\text{C}$ / -328 to 1562 $^{\circ}\text{F}$	0.01 $^{\circ}\text{C}$ / 0.01 $^{\circ}\text{F}$	$\pm 0.1\text{ }^{\circ}\text{C}$ / $\pm 0.2\text{ }^{\circ}\text{F}$	IEC-60751
Pt-1000	-200 to 400 $^{\circ}\text{C}$ / -328 to 752 $^{\circ}\text{F}$	0.1 $^{\circ}\text{C}$ / 0.1 $^{\circ}\text{F}$	$\pm 0.1\text{ }^{\circ}\text{C}$ / $\pm 0.2\text{ }^{\circ}\text{F}$	IEC-60751
Cu-10	-200 to 260 $^{\circ}\text{C}$ / -328 to 500 $^{\circ}\text{F}$	0.1 $^{\circ}\text{C}$ / 0.1 $^{\circ}\text{F}$	$\pm 2.0\text{ }^{\circ}\text{C}$ / $\pm 4.0\text{ }^{\circ}\text{F}$	Minco 16-9
Ni-100	-60 to 250 $^{\circ}\text{C}$ / -76 to 482 $^{\circ}\text{F}$	0.1 $^{\circ}\text{C}$ / 0.1 $^{\circ}\text{F}$	$\pm 0.2\text{ }^{\circ}\text{C}$ / $\pm 0.4\text{ }^{\circ}\text{F}$	DIN-43760

	Input Ranges	Resolution	Accuracy	Remarks
probe*	-210 to 850 °C / -328 to 1562 °F	0.01 °C / 0.01 °F	± 0.1 °C / ± 0.2 °F	IEC-60751
TC-J	-210 to 1200 °C / -346 to 2192 °F	0.01 °C / 0.01 °F	± 0.10 °C / ± 0.20 °F	IEC-60584
TC-K	-270 to -150 °C / -454 to -238 °F	0.01 °C / 0.01 °F	± 0.25 °C / ± 0.50 °F	IEC-60584
TC-K	-150 to 1370 °C / -238 to 2498 °F	0.01 °C / 0.01 °F	± 0.10 °C / ± 0.20 °F	IEC-60584
TC-T	-260 to -200 °C / -436 to -328 °F	0.01 °C / 0.01 °F	± 0.30 °C / ± 0.60 °F	IEC-60584
TC-T	-200 to -75 °C / -328 to -103 °F	0.01 °C / 0.01 °F	± 0.20 °C / ± 0.40 °F	IEC-60584
TC-T	-75 to 400 °C / -103 to 752 °F	0.01 °C / 0.01 °F	± 0.10 °C / ± 0.20 °F	IEC-60584
TC-B	50 to 250 °C / 122 to 482 °F	0.01 °C / 0.01 °F	± 1.25 °C / ± 2.50 °F	IEC-60584
TC-B	250 to 500 °C / 482 to 932 °F	0.01 °C / 0.01 °F	± 0.75 °C / ± 1.50 °F	IEC-60584
TC-B	500 to 1200 °C / 932 to 2192 °F	0.01 °C / 0.01 °F	± 0.50 °C / ± 1.00 °F	IEC-60584
TC-B	1200 to 1820 °C / 2192 to 3308 °F	0.01 °C / 0.01 °F	± 0.35 °C / ± 0.70 °F	IEC-60584
TC-R	-50 to 300 °C / -58 to 572 °F	0.01 °C / 0.01 °F	± 0.50° C / ± 1.00 °F	IEC-60584
TC-R	300 to 1760 °C / 572 to 3200 °F	0.01 °C / 0.01 °F	± 0.35° C / ± 0.70 °F	IEC-60584
TC-S	-50 to 300 °C / -58 to 572 °F	0.01 °C / 0.01 °F	± 0.50° C / ± 1.00 °F	IEC-60584
TC-S	300 to 1760 °C / 572 to 3200 °F	0.01 °C / 0.01 °F	± 0.35° C / ± 0.70 °F	IEC-60584

TC-E -270 to -150 °C / -454 to -238 °F	0.01 °C / 0.01 °F	± 0.15 °C / ± 0.30 °F	IEC-60584
TC-E -150 to 1000 °C / -238 to 1832 °F	0.01 °C / 0.01 °F	± 0.05 °C / ± 0.10 °F	IEC-60584
TC-N -260 to -200 °C / -436 to -328 °F	0.01 °C / 0.01 °F	± 0.50 °C / ± 1.00 °F	IEC-60584
TC-N -200 to -20 °C / -328 to -4 °F	0.01 °C / 0.01 °F	± 0.20 °C / ± 0.40 °F	IEC-60584
TC-N -20 to 1300 °C / -4 to 2372 °F	0.01 °C / 0.01 °F	± 0.10 °C / ± 0.20 °F	IEC-60584
TC-L -200 to 900 °C / -328 to 1652 °F	0.01 °C / 0.01 °F	± 0.10 °C / ± 0.20 °F	DIN-43710
TC-C 0 to 1500 °C / 32 to 2732 °F	0.01 °C / 0.01 °F	± 0.25 °C / ± 0.50 °F	W5Re / W26Re
TC-C 1500 to 2320 °C / 2732 to 4208 °F	0.01 °C / 0.01 °F	± 0.35 °C / ± 0.70 °F	W5Re / W26Re

(*) Probe is a spare input for a reference RTD in order to use as standard thermometer. The accuracy is related to calibrator only.

1.3. Specifications - Outputs

	Output Ranges	Resolution	Accuracy	Remarks
millivolt	-10 mV to 110 mV	0.0001 mV	± 0.01 % FS	$R_{out} < 0.3 \Omega$
volt	-0.5 V to 12 V	0.0001 V	± 0.02 % FS	$R_{out} < 0.3 \Omega$
mA	0 to 24 mA	0.0001 mA	± 0.02 % FS	$R_{max} = 700 \Omega$
2-wire Transmitter (XTR)	4 mA to 24 mA	0.0001 mA	± 0.02 % FS	$V_{max} = 60$ V
Resistance	0 to 400 Ω 400 to 2500 Ω	0.01 Ω 0.1 Ω	± 0.02 % FS ± 0.03 % FS	For external excitation current of 1.0 mA
Pt-100	-200 to 850 $^{\circ}\text{C}$ / -328 to 1562 $^{\circ}\text{F}$	0.01 $^{\circ}\text{C}$ / 0.01 $^{\circ}\text{F}$	± 0.2 $^{\circ}\text{C}$ / ± 0.4 $^{\circ}\text{F}$	IEC-60751
Pt-1000	-200 to 400 $^{\circ}\text{C}$ / -328 to 752 $^{\circ}\text{F}$	0.1 $^{\circ}\text{C}$ / 0.1 $^{\circ}\text{F}$	± 0.1 $^{\circ}\text{C}$ / ± 0.2 $^{\circ}\text{F}$	IEC-60751
Cu-10	-200 to 260 $^{\circ}\text{C}$ / -328 to 500 $^{\circ}\text{F}$	0.1 $^{\circ}\text{C}$ / 0.1 $^{\circ}\text{F}$	± 2.0 $^{\circ}\text{C}$ / ± 4.0 $^{\circ}\text{F}$	Minco 16-9
Ni-100	-60 to 250 $^{\circ}\text{C}$ / -76 to 482 $^{\circ}\text{F}$	0.1 $^{\circ}\text{C}$ / 0.1 $^{\circ}\text{F}$	± 0.2 $^{\circ}\text{C}$ / ± 0.4 $^{\circ}\text{F}$	DIN-43760
TC-J	-210 to 1200 $^{\circ}\text{C}$ / -346 to 2192 $^{\circ}\text{F}$	0.01 $^{\circ}\text{C}$ / 0.01 $^{\circ}\text{F}$	± 0.20 $^{\circ}\text{C}$ / ± 0.40 $^{\circ}\text{F}$	IEC-60584
TC-K	-270 to -150 $^{\circ}\text{C}$ / -454 to -238 $^{\circ}\text{F}$	0.01 $^{\circ}\text{C}$ / 0.01 $^{\circ}\text{F}$	± 0.50 $^{\circ}\text{C}$ / ± 1.00 $^{\circ}\text{F}$	IEC-60584
TC-K	-150 to 1370 $^{\circ}\text{C}$ / -238 to 2498 $^{\circ}\text{F}$	0.01 $^{\circ}\text{C}$ / 0.01 $^{\circ}\text{F}$	± 0.20 $^{\circ}\text{C}$ / ± 0.40 $^{\circ}\text{F}$	IEC-60584

	Output Ranges	Resolution	Accuracy	Remarks
	TC-T -260 to -200 °C / -436 to -328 °F	0.01 °C / 0.01 °F	± 0.60 °C / ± 1.20 °F	IEC-60584
	TC-T -200 to -75 °C / -328 to -103 °F	0.01 °C / 0.01 °F	± 0.40 °C / ± 0.80 °F	IEC-60584
	TC-T -75 to 400 °C / -103 to 752 °F	0.01 °C / 0.01 °F	± 0.20 °C / ± 0.40 °F	IEC-60584
	TC-B 50 to 250 °C / 122 to 482 °F	0.01 °C / 0.01 °F	± 2.50 °C / ± 5.00 °F	IEC-60584
	TC-B 250 to 500 °C / 482 to 932 °F	0.01 °C / 0.01 °F	± 1.50 °C / ± 3.00 °F	IEC-60584
	TC-B 500 to 1200 °C / 932 to 2192 °F	0.01 °C / 0.01 °F	± 1.00 °C / ± 2.00 °F	IEC-60584
	TC-B 1200 to 1820 °C / 2192 to 3308 °F	0.01 °C / 0.01 °F	± 0.70 °C / ± 1.40 °F	IEC-60584
	TC-R -50 to 300 °C / -58 to 572 °F	0.01 °C / 0.01 °F	± 1.00 °C / ± 2.00 °F	IEC-60584
	TC-R 300 to 1760 °C / 572 to 3200 °F	0.01 °C / 0.01 °F	± 0.50 °C / ± 1.00 °F	IEC-60584
	TC-S -50 to 300 °C / -58 to 572 °F	0.01 °C / 0.01 °F	± 1.00 °C / ± 2.00 °F	IEC-60584
	TC-S 300 to 1760 °C / 572 to 3200 °F	0.01 °C / 0.01 °F	± 0.50 °C / ± 1.00 °F	IEC-60584
	TC-E -270 to -150 °C / -454 to -238 °F	0.01 °C / 0.01 °F	± 0.30 °C / ± 0.60 °F	IEC-60584
	TC-E -150 to 1000 °C / -238 to 1832 °F	0.01 °C / 0.01 °F	± 0.10 °C / ± 0.20 °F	IEC-60584
	TC-N -260 to -200 °C / -436 to -328 °F	0.01 °C / 0.01 °F	± 1.00 °C / ± 2.00 °F	IEC-60584
	TC-N -200 to -20 °C / -328 to -4 °F	0.01 °C / 0.01 °F	± 0.40 °C / ± 0.80 °F	IEC-60584
	TC-N -20 to 1300 °C / -4 to 2372 °F	0.01 °C / 0.01 °F	± 0.20 °C / ± 0.40 °F	IEC-60584

TC-L -200 to 900 °C / -328 to 1652 °F	0.01 °C / 0.01 °F	± 0.20 °C / ± 0.40 °F	DIN-43710
TC-C 0 to 1500 °C / 32 to 2732 °F	0.01 °C / 0.01 °F	± 0.50 °C / ± 1.00 °F	W5Re / W26Re
TC-C 1500 to 2320 °C / 2732 to 4208 °F	0.01 °C / 0.01 °F	± 0.70 °C / ± 1.40 °F	W5Re / W26Re

Accuracy values are valid within a year and temperature range of 20 to 26 °C. Outside these limits add 0.001 % FS / °C taking 23 °C as the reference temperature. For thermocouples, using the internal cold junction compensation add a cold junction compensation error of ± 0.1 °C or ± 0.2 °F max.

Probe

Independent input for RTD (**Probe**). Probe is a high accuracy 4-wire Pt100 available under previous consult.

Software Special Functions

- Any output programmable in:

- 1) **STEP**: 10%, 20%, 25% or up to 11 programmable setpoints via key or adjustable time.
- 2) **RAMP**: up and down with programmable travel and dwell time.

- Special functions:

- 1) **SCALE**: makes the scaling of both input and output in 6 digits and allows the configuration of decimal point.
- 2) **CAL**: scales the input in same unit of output.
- 3) **CONV**: converts any input into any output, galvanically isolated.

- **MEM command:** It can store up to eight types of configuration chosen by user.

Measures 2, 3 and 4-wire RTDs.

Transmitter Power Supply: 24 Vdc/22 mA.

50 Vdc In/Out isolation.

Five-minute warm-up time.

Operating temperature range: 0 to 50 °C.

Relative humidity: 90% RH non-condensing.

Nickel-Metal Hydride (Ni-MH) rechargeable batteries, up to 8 hours of operation, depending on the functions used.

RS-232/485 Serial Communication.

Includes instruction manual, carrying case, test leads, spare fuse, banana plug and battery charger.

Optional Certificate of Calibration.

Dimensions: 91 mm x 213 mm x 44 mm (height, width and depth).

Weight: 1.0 kg approx.

One-year warranty.

Notes: 1- TC-512-HP and ISOPLAN are Presys trade marks.

2- Changes can be introduced in the instrument, altering specifications in this manual.

2 - Operation

2.1. Parts Identification

Front panel

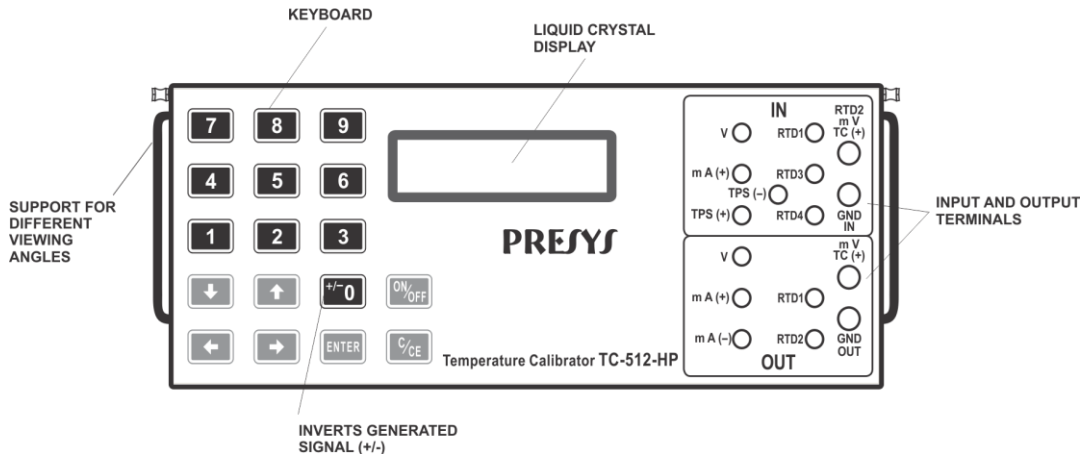

Fig. 01 - Front Panel

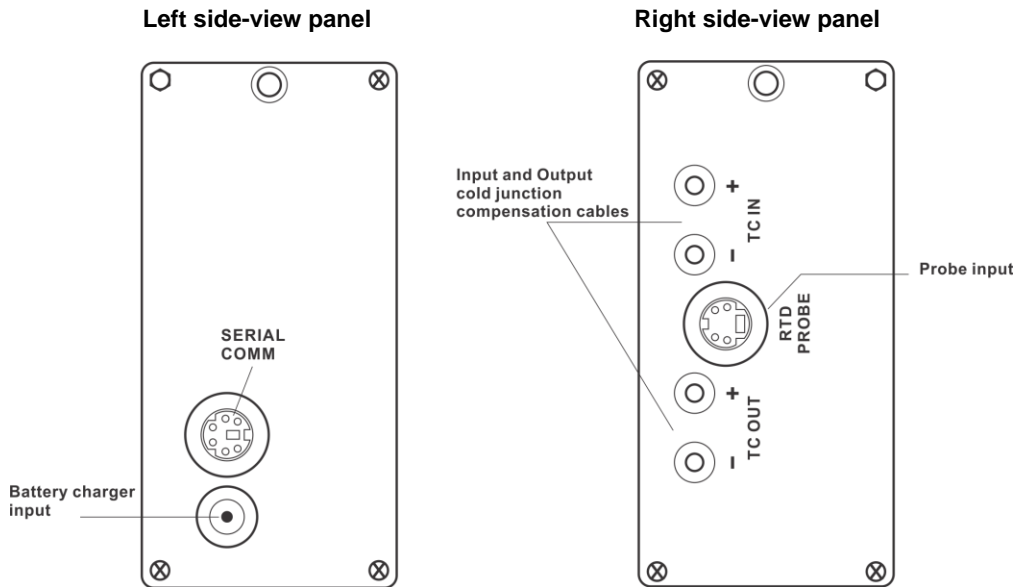
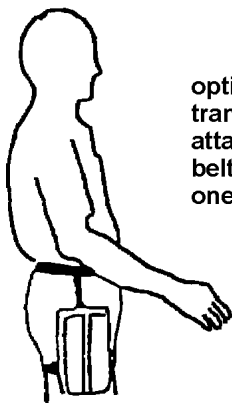
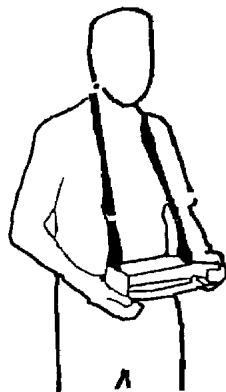

Fig. 02 - Side Panels

Ways to use the transport bag



options for transport:
attached to the
belt or held over
one's shoulder



Used in the field,
the calibrator is
attached to the
bag by means of
velcro, which can
be detached for
workbench use.

Fig. 03 - Ways to use the transport bag

Accessories: The bag has two compartments; one is used to house the calibrator and the other is used to keep several accessories such as probes, adaptor to connect thermocouple wires, spare fuse, straps for transport and use in the field, and also the technical manual.

Optional Items: the following items are optional, including the precision temperature sensor (**Probe**), the high precision external cold junction compensation block, RS-232/485 interface and the calibration software. The optional items are described in specific manuals.

2.2. Battery and charger

The calibrator is supplied with a rechargeable battery which enables up to 8 hours. This autonomy is reduced when the current output or the 24 V power supply for transmitters. A charger is also provided, which can be connected to 110 or 220 Vac. Care should be taken when changing the 110-220 Vac selection switch in the charger; time required for a full charge is 14 hours. When the display indicates **LOW BAT**, it is necessary to recharge the instrument, which will continue in operation for a few minutes. The charger provides the battery charge while it feeds the calibrator, thus permitting the calibrator to be used normally while the battery is being charged.

The batteries used by the calibrator are made of Nickel - Metal Hydride (Ni - MH). This new technology for rechargeable batteries does not have the undesirable characteristics of memory effect and environmental pollution as their preceding batteries made of Nickel Cadmium (Ni-Cd).

2.3. Using the Calibrator: basic functions

When powered on, the calibrator goes through a self-test routine and shows the last adjustment date and the value of the battery voltage. In case of failure, it displays a message to indicate RAM error or E2PROM error; if that occurs, the instrument should be sent for repair. The battery voltage is constantly monitored and the low battery warning is provided.

After the self-test is completed, the display shows the starting menu:

⇒ IN	OUT	EXEC
CONF	ADJ	COM

IN / OUT - selects the input/output functions

ADJ - selects functions which adjust the calibrator itself (see chapter on Adjustment).

Do not enter in **ADJ** option before reading the warning in section 3 on adjustment.

COM - Refers to the communication with the computer, described in an appropriate manual.

EXEC - Used to activate an input or output option which has been previously selected.

CONF - takes to the sub-menu:

⇒ CF	PRG	MEM	DATE
FN	BAT	LCD	

CF changes both the input and output temperature units from °C to °F and vice-versa. It also enables to choose the temperature scale between IPTS-68 and ITS-90. It follows the encoding scheme described below:

°C-90 ITS-90 temperature scale in Celsius degrees.

°F-68 IPTS-68 temperature scale in Fahrenheit degrees.

DATE updates the internal date and time of the calibrator. Thus, when it performs a calibration previously programmed by the ISOPLAN software, calibration data is recorded together with their date and time of occurrence. Whenever the calibrator is turned off, these data are not updated any longer. Thus, if you want the date and time to be recorded together with the calibration, one should update these data either by means of the keyboard or automatically via the ISOPLAN software. For such, use the vertical arrow keys **↑** and **↓** to change the value which is blinking and the horizontal arrow keys **←** and **→** to go to another value. The ENTER key confirms the last selection.

BAT shows the value of the battery voltage

Battery level	Battery state	Display
4.0 to 7.0 V	normal	_____
< 4.0 V	low	LOW BAT

LCD performs the setting of the display contrast by means of arrow keys **↑** and **↓**. Save the last selection by pressing the ENTER key.

PRG, **FN** and **MEM** are calibrator special resources described further on.

2.4. Measurement or input functions

Select the type of the signal to be measured by using the menus and use the corresponding terminals:

- a) **IN** Selects the input function and the ENTER key should be pressed.

⇒	V	mV	mA	Ohm	OP
	TC	RTD	SW	NO	

Press ENTER to select volt measurement; press ↓, ↑, ← and → to select another signal.

IN = x.xxxx V

Display indicates volt input.

C/CE

Goes back to previous menu

The other magnitudes follow the same selection process.

When performing the measurement of **OHM**, you must also select the 2-, 3- or 4-wire options. For **TC** (thermocouple), you must select the thermocouple type and cold junction compensation type: **Internal**, **Manual** or **Probe**. With the **Internal** option, compensation is performed internally; in **Manual**, it is necessary to provide the calibrator with the cold junction temperature value, by entering the digits through the numeric keypad. The **Probe** option corresponds to the cold junction measurement through the probe or high precision external cold junction compensation block (CJCB-10). You can use this precision block in order to measure the cold junction of the thermocouple input as well as of the output. For connection details, see item d) in this section.

For **RTD** (thermoreistance), you must select the type and connection for the 2-, 3- or 4-wire options.

The input in contact (**SW**) serves to measure the continuity of an external circuit connected to the calibrator RTD1 and RTD4 inputs. When there is continuity, the input indicates **CLOSED**; otherwise, **OPEN** is indicated.

Its most important application is when it is used together with the calibrator output with the purpose of detecting the setpoint of the alarm trigger of an instrument. In this case, the calibrator output is connected to the instrument input and the instrument relay output is connected to the calibrator contact input. The display takes on the following configuration for current output:

OPEN = 12.0000mA
OUT = 12.0000mA

In other words, the calibrator output is copied to its input until the moment when the switch changes position; at that time, the input is frozen and the display will show then:

LOCK = 12.0000mA
OUT = 16.0000mA

The value displayed in the display upper line together with **LOCK** is the setpoint of the relay alarm. The input is released only when the arrow key ← is pressed.

The **OP** option refers to the temperature optional module and belongs to both the calibrator input (**IN**) and output (**OUT**). Pressing ENTER after selecting **OP** takes to the sub-menu:



Probe is related to temperature measurement with an optional 4-wire Pt100 probe. When using the **Probe**, temperatures ranging from – 200.00 °C to 850.00 °C can be measured with high accuracy.

When input sensors break: RTD, resistance and probe, the display shows the burn-out warning identified by the symbol illustrated below:

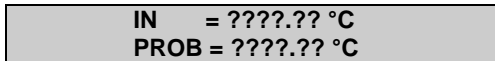

Whenever the input signal (**IN**) is under or over the input ranges established in item 1.2 on Specifications the display will show **UNDER** or **OVER**, respectively.

The **NO** option deactivate the input function.

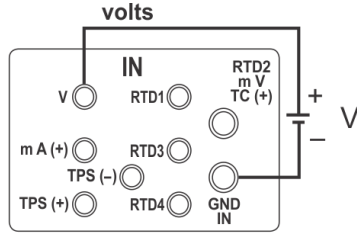
b) Input or measurement connections

(A)

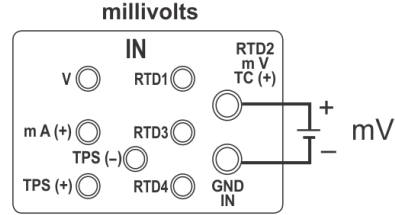

(B)

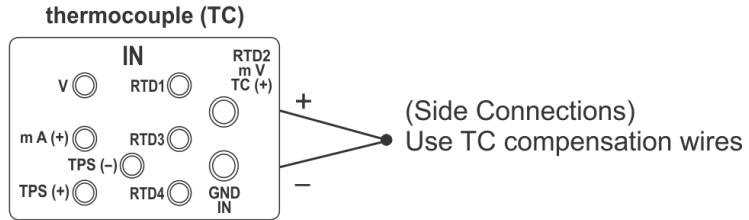

(C)

Fig. 04 - Input Connections

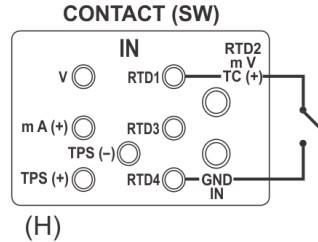
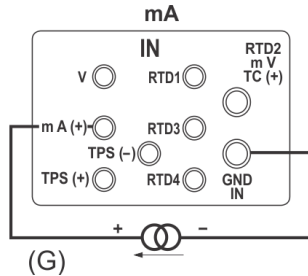
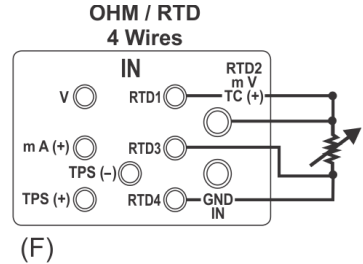
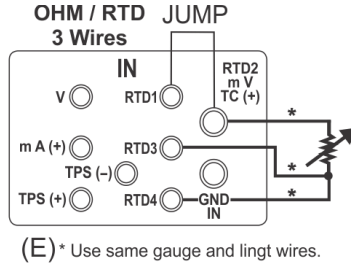
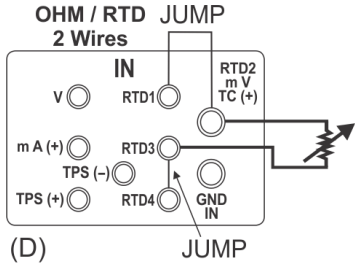

Fig. 04 - (Cont.) Input Connections

c) Probe Connection (optional)

Connect the Probe to calibrator so that polarity identification (white mark) coincide. Refer to figure below.

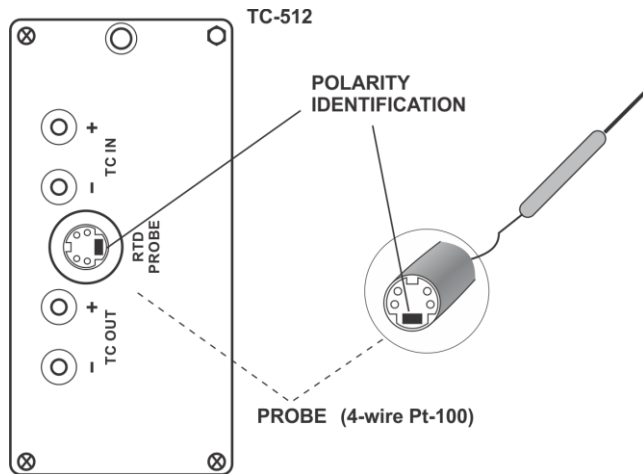

Fig. 05 – Probe Connection

d) High accuracy external cold junction compensation block connection – CJCB (optional)

Insert the high precision block in the TC input (IN) or TC output (OUT) terminals, and connect the cable which comes out of the block to calibrator Probe connector according to the same polarity described in item c) above. Depending on the block insertion in the TC input or in the TC output, the thermocouple connection will have its input or output cold junction given by the external compensation block. The input or output thermocouple connection must be made in the external compensation block itself. See the following figures:

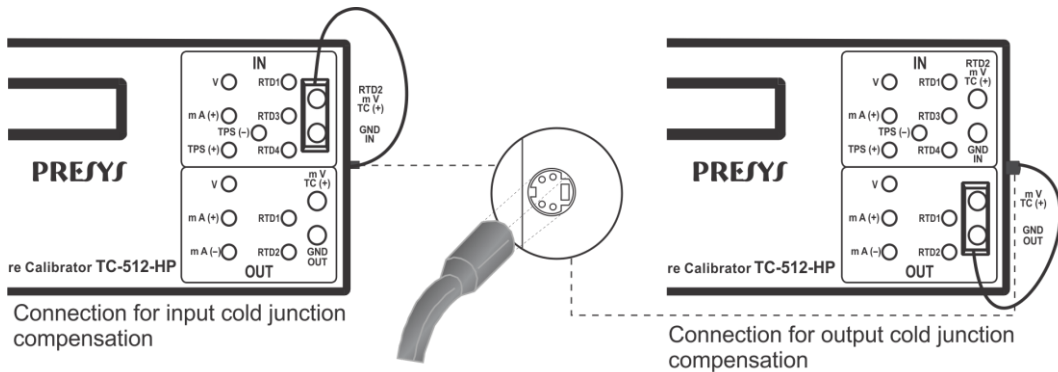

Fig. 06 - CJCB Connection

For an effective input or output cold junction measurement with the block, Probe option of thermocouple cold junction must be selected and enabled. Select Probe and press ENTER.

2.5. Generation or output functions

Select through the menus the type of signal to be generated and use the corresponding terminals:

a) **OUT** Selects the output functions.

⇒ V	mV	mA	Ohm	OP
TC	RTD	NO		

Press ENTER to select volt generation, press ↓, ↑, ← and → to select another signal.

OUT = x.xxxx V Display indicates the output value in volts. Signal may be inverted by using key 0 (+ / -).

C/CE Goes back to the previous menu.

For the **RTD** or **OHM** generation, the calibrator simulates electronically a resistance value, that is, there is no resistor but an electronic circuit which behaves as a resistor. It was designed specifically with the purpose of simulating thermoresistances so that the resistor can be connected to instruments such as indicators, transmitters,

temperature controllers, with an excitation current within the range of 150 μA to 5 mA. For the **OHM** generations, you should choose between the range of 400 Ω and 2500 Ω .

For the thermocouple generation, you should choose the type of thermocouple and the type of cold junction compensation.

The **OP** option is the same as it is described for input functions.

The **NO** option deactivate the output function.

b) Output or generation connections

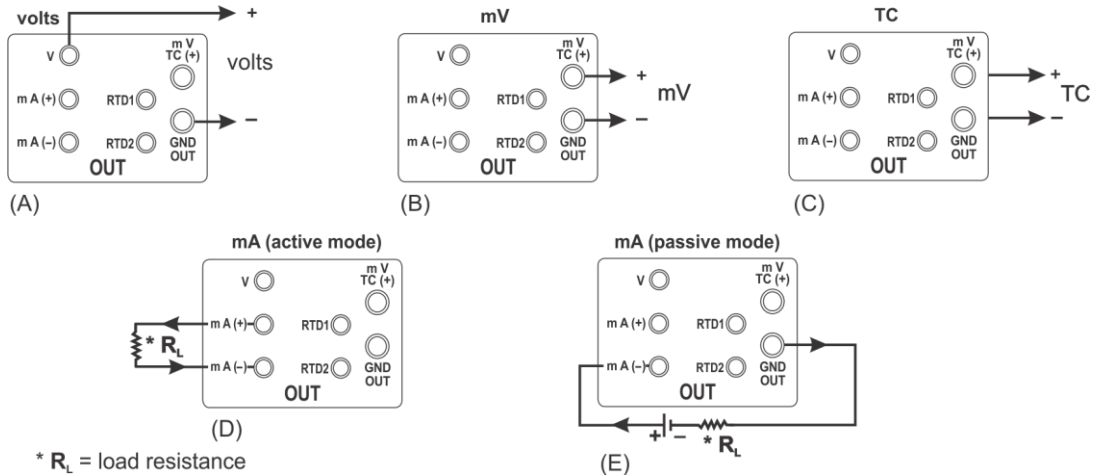
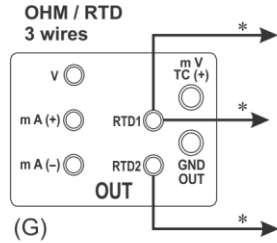
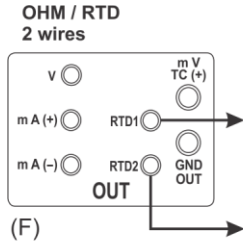
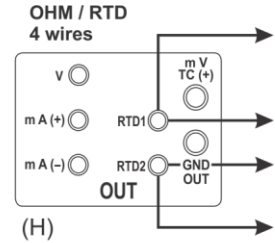

Fig. 07 - Output Connection



(*) Use same gauge
and length wires.



Note: No polarity for resistance output.

Fig. 07 - (Cont.) Output Connection

2.6. Available power supplies

The calibrator has two power supplies galvanically isolated: TPS and +24 Vdc at the output, both provided with short-circuit protection (current limited to 30 mA).

ATTENTION:
The TPS voltage,
without load,
may reach values
higher than rated.

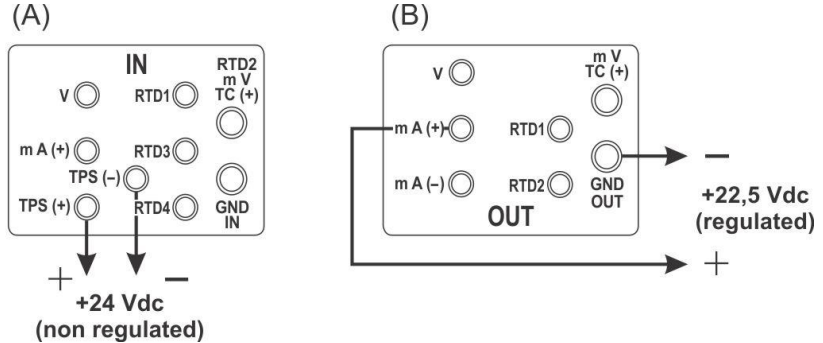

Fig. 08 - Power Supplies

2.7. Calibration examples

a) Calibration of a temperature transmitter with RTD input and 4-20 mA output.

Through the menus, the calibrator is configured for **mA** input and **RTD** output. TPS, which stands for Transmitter Power Supply, is a 24 Vdc power supply (rated voltage, which may vary depending on the load) which feeds power to transmitter.

In the example, the thermoresistance connection is made by using three wires, and it is simulated by the calibrator. With this kind of connection, there is no measurement error due to the resistance of wires provided that they have the same length and gauge.

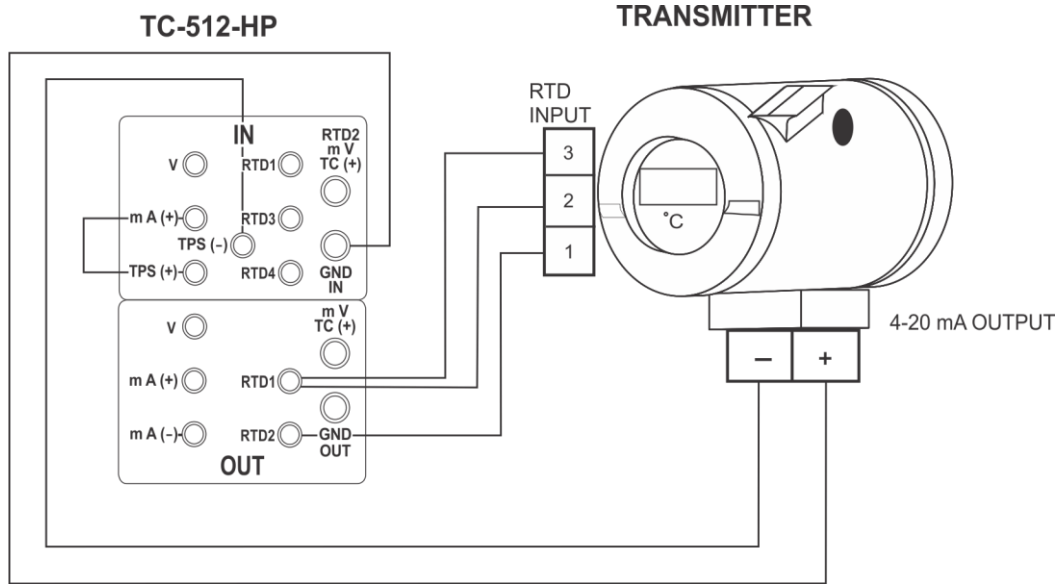

Fig. 09 - Calibration of a temperature transmitter with RTD 3-wire input.

b) Calibration of a four-wire temperature transmitter with thermocouple input (TC) and 1-5 Vdc output.

Is configured for volt input and TC output (the type of TC should be selected). For the cold junction compensation, you may use the TC compensation wires to set up the connection between the transmitter and the calibrator and program the option for automatic cold junction (**Internal**), or you may measure the temperature of the transmitter terminal set and then enter this value into the calibrator **Manual** option, thus avoiding the use of compensation wires.

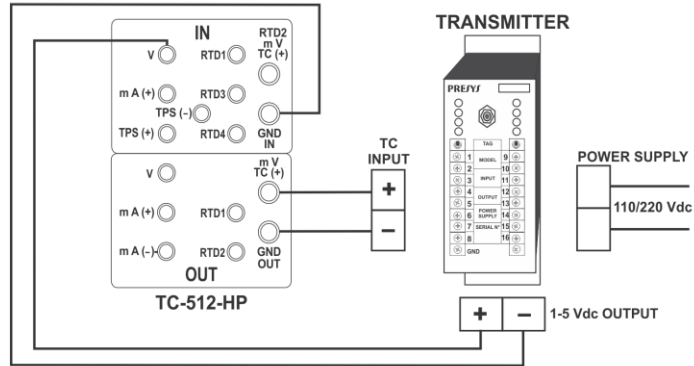

Fig. 10 - Calibration of a four-wire temperature transmitter with thermocouple input (TC) and 1-5 Vdc output.

2.8. Special Programming

When **PRG** is selected, the display will show:



This option allows you to select a number of special programming features for **INPUT** or **OUTPUT**. **INPUT** is provided with **FILTER** and **DECIMAL** options. **OUTPUT** is provided with **STEP** and **RAMP** options.

2.8.1. FILTER Programming

The value of this parameter (in seconds) supplies the time constant of a first order digital filter attached to the selected input. When filtering the measured signal is not required, you should simply set this parameter to zero.

2.8.2. DECIMAL Programming

The value of this parameter (**0**, **1**, **2**, **3** or **DEFAULT**) indicates the number of decimals with which the value measured at the input will be shown in the display.

Note: **DEFAULT** corresponds to the maximum number of decimals that may display in an input measurement, in compliance with its resolution.

2.8.3. STEP Programming

The **STEP** programming makes the calibrator output vary in pre-defined steps. It is useful in calibrations where some scale points are verified; for example 0% - 25% - 50% - 75% - 100%.

The output type must be previously configured, otherwise the **Select OUTPUT first** message is shown. In this case, press C/CE to go back to the main menu in order to select the input type.

To activate this programming from the main menu, select **CONF** (ENTER), **PRG** (ENTER) and then **STEP** (ENTER). After this sequence, you will have the options **10%**, **20%**, **25%** and **VARIABLE**; these options define the percentage of variation at the output for each step, the **VARIABLE** option allows you to program the setpoint values of each step, up to a maximum of eleven values.

After the selection of the step variation percentage is completed, the start and the end value of the range within which the output will travel (**High** and **Low setpoint**) are prompted.

By continuing, you go back to the main menu and activate **EXEC**, the output now performs the **STEP** programming, always starting with the beginning of the range, and the arrow keys ↓ or ↑ must be pressed when you want to skip to the following steps.

By pressing the arrow key →, each step will be reached automatically after a preset time is elapsed, which is defined through the keys: 1 (10s), 2 (20s), 3 (30s), 4 (40s), 5 (50s), 6 (60s), 7 (70s), 8 (80s) and 9 (90s). These times are only enabled, once the arrow key → has been pressed, what changes the **STEP** mnemonic to **0s**. Under this situation, the steps are automatically and permanently scanned. If you wish to quit this mode (**STEP** set by time), simply press the arrow key →.

2.8.4. RAMP Programming

By using this programming, the calibrator output varies automatically, thus producing ramps and level marks which may be programmed to actuate once or continuously.

The output type must be previously configured, otherwise the **Select OUTPUT first** message is shown. In this case, press C/CE to go back to the main menu in order to select the input type.

From the main menu, select **CONF** (ENTER), **PROG** (ENTER), and **RAMP** (ENTER). Then you must enter the start and the end values of the range within which the output will travel (**High** and **Low setpoint**), and also the value of time (in seconds) required for a complete travel within the range (**Ramp Time**). Another value that may be configured is how long it should dwell at the level mark (**Dwell Time**), that is, the time during which the output remains constant between two ramps.

After the configuration is complete, you have to go back to the main menu and press **EXEC**; the output goes to the starting value of the configured range. When the arrow key **↑** is pressed, an ascending cycle is started, and pressing **↓**, a descending cycle begins, only once. Pressing **↑** and **↓**, cycles are obtained on a continuous basis.

2.9. Special Functions

Selecting **FN** the display will show:



With these options, you may select special functions related to the **INPUT** or the **OUTPUT**. **INPUT** has the **SCALE**, **CAL** and **NO** options.

The input type must be previously configured, otherwise the **Select INPUT first** message is shown. In this case, press C/CE to go back to the main menu in order to select the input type.

2.9.1. SCALE Function

It establishes a linear relationship between the calibrator input signal and what is shown at the display, according to the graphic below.

The scaled indication at the display (#) may represent any engineering unit, such as: m/s, m³/s, %, etc.

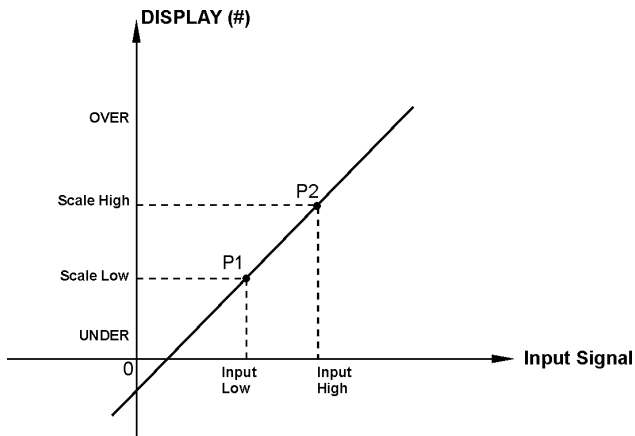

Fig. 11 - SCALE Function (LINEAR).

The number of decimals, up to 4, shown at the display may be configured by using parameter **Scale Dec**.

The value for **Input High** must be necessarily higher than **Input Low**. On the other hand, **Scale High** and **Scale Low** may have any relationship between themselves: higher than, lower than or equal to, and they may have a signal before them. Thus direct or reverse relationships may be established.

The contact input may not be scaled.

For the current input, a linear relationship may be established as it has been previously shown or it may be squared (**FLOW**) as illustrated below:

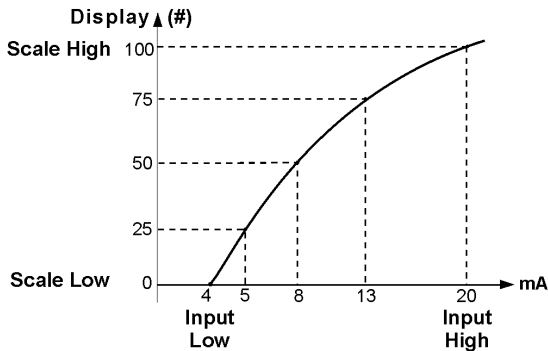

Fig. 12 - SCALE Function (FLOW).

2.9.2. CAL Function

The calibrator may be used to calibrate or adjust any transmitter type. In a typical application, it would generate a thermoresistance signal and would measure the output signal in the current input. Due to reasons of quickness and easiness to compare errors at the input and output of the transmitter, the reading of the calibrator current input may be displayed with the same unit of the generated signal, that is, units of temperature. Thus, both readings for the calibrator input and output are scaled in units of temperature and the error can be promptly calculated.

To activate this function, simply fill in the four parameters shown in the graphic below. To access these parameters, press ENTER after **CAL** is indicated in the display.

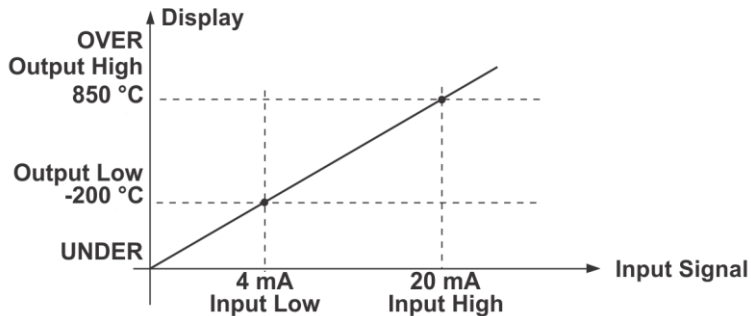
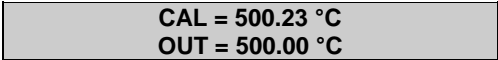

Fig. 13 - CAL Function (LINEAR).

Note that when the **CAL** function is active, the display will indicate **CAL** instead of **IN** as illustrated as follows:



CAL = 500.23 °C
OUT = 500.00 °C

To disable the **SCALE** or **CAL** functions, simply select the **NO** option from the menu below and press ENTER.



SCALE CAL ⇒ NO

OUTPUT has the **SCALE**, **CONV** and **NO** options described as follows.

The output type must be previously configured, otherwise the **Select OUTPUT first** message is shown. In this case, press C/CE to go back to the main menu in order to select the input type.

2.9.3. SCALE Function

The scaling of the calibrator output allows it to simulate the functioning of a transmitter. Transmitter input is made directly by keyboard, and one can get any signal generated by the calibrator as the output signal.

SCALE output function relates the output signal generated by the calibrator to the value shown on display, according to the figure below:

The scaled indication at the display (#) may represent any engineering unit, such as: m/s, m³/s, %, etc.

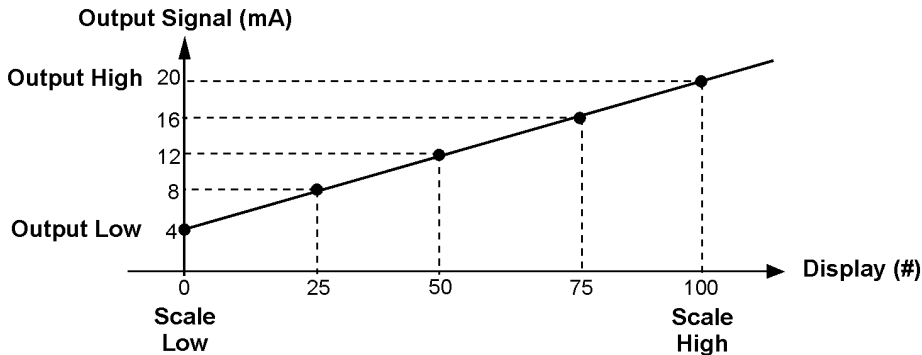

Fig. 14 - SCALE Function (LINEAR).

Scale Dec parameter configures the number of decimals presented at the display.

The value of **Output High** must always be higher than **Output Low**. **Scale Low** and **Scale High** parameters may have any relationship between them, provided that they are different. Thus direct or reverse relationships may be established.

Any type of output may be scaled.

In case of current output, as well as for the input, a linear or squared (**FLOW**) relationship may be established, as the example provided below.

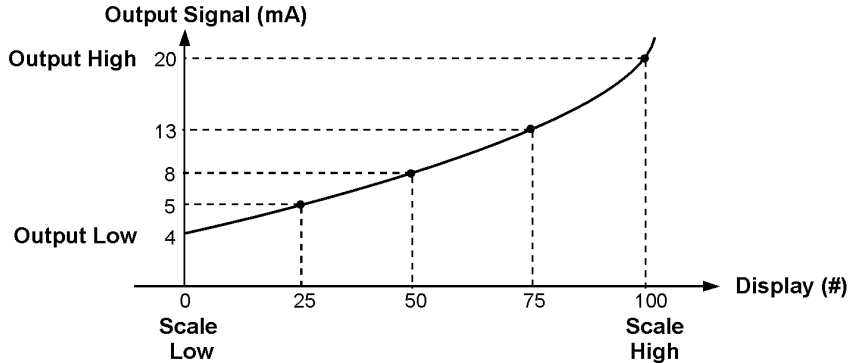

Fig. 15 - SCALE Function (FLOW).

2.9.4. CONV Function

By using the **CONV** function, the calibrator may convert any input signal into any output signal with galvanic isolation. It may therefore behave as a real transmitter.

Once the calibrator input and output have been selected, you must fill in the four parameters shown in the graphic below. To access these parameters press ENTER after **CONV** is indicated at the display.

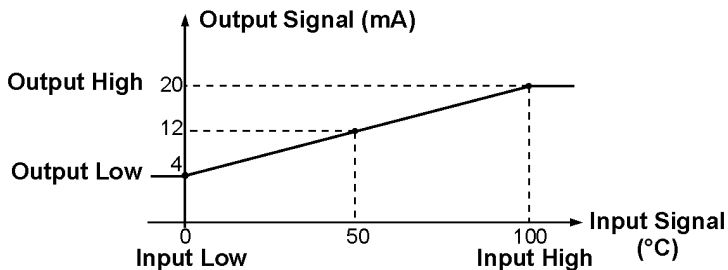

Fig. 16 - CONV Function

The value of **Output High** must always be higher than **Output Low**. **Input High** and **Input Low** parameters must never be equal. Thus any type of direct or reverse retransmission, from input to output, may be obtained.

SCALE and **CONV** functions may be disabled by selecting the **NO** option and pressing ENTER, as shown below:



2.10. MEM Command

The calibrator accepts a great amount of programmations and special functions that can be often used. In this case, storage of these configurations in the calibrator saves time. One can have up to eight sequences stored in memory.

After making a specific operation in the calibrator through the keyboard, return to the menu that shows **MEM**. Then select **MEM** and press ENTER. The display shows:



Select **WRITE** and press ENTER. The display will show:



The numbers shown above represent eight locations of memory. Select any of them and press ENTER. The current configuration is then stored in the chosen memory location. In order to recall it, even though the calibrator is turned off and on, select **RECALL** (ENTER) and the memory number that stored the previous configuration. Then press ENTER.

Any new configuration can be written over an already used memory location.
When you want to clear all eight memory locations, select **CLEAR ALL** and press ENTER.

2.11. Warning Messages

Warning	Meaning	Procedure
RAM ERROR READ MANUAL	Problem in RAM memory	Turn the calibrator off and on. If the error persists, send the instrument to the factory
EEPROM ERROR READ MANUAL	Problem in EEPROM memory	Same as the previous item
LOW RESISTANCE	Short-circuit in mV, TC or V output	Check the impedance at the input circuit connected to the calibrator
CHECK LOOP	mA output is open	Check the continuity of the wiring
LOW BAT	Level of battery voltage is low	Connect the calibrator charger
?????? °C	Input sensor is open	Check input connections and sensor
UNDER / OVER	Input signal out of specifications or scaling range	See item 1.2 on Input Specifications

3 - Adjustment

Warning: Enter the following options only after understanding them completely. Otherwise, it may be necessary to return the instrument to the factory for readjustment.

Select **ADJ** option from the main menu and press the ENTER key. You should then enter the **PASSWORD** 9875 to access the adjustment menu.

The password functions as a protection to adjustment ranges. After the password is entered the menu displays the options:



You should then choose whether the adjustment is to be performed over an input range (**IN**) or an output range (**OUT**). **DATE** is an option which allows you to record the date on which the adjustment will be performed and once it has been filled in, it will be displayed every time the instrument is turned on.

Options for **IN** adjustment:

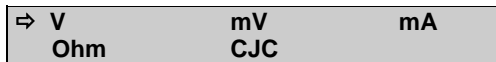

Options for **OUT** adjustment:

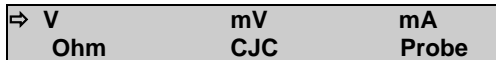

Simply note that the thermocouples will only be adjustment after the **mV** and cold junction (**CJC**) adjustment have been performed. Only in case of **OHM** or **RTD**, you have to perform the **mV** adjustment first.

3.1. Input adjustment (IN)

Select the corresponding mnemonic and apply the signals presented in the tables below.

When adjusting inputs, the display shows on the 2nd line the value measured by and on the first line the same value is expressed as a percentage.

Note that the applied signals just need to be close to values shown in the table.

Once the signal has been applied, store the values of the 1st and 2nd calibration points by pressing keys 1 (1st point) and 2 (2nd point).

mV Input	1st point	2nd point
G_4	0.0000 mV	70.0000 mV
G_3	0.0000 mV	120.0000 mV
G_2	0.0000 mV	600.0000 mV
G_1	600.0000 mV	2400.0000 mV

V Input	1st point	2nd point
Faixa única	0.00000 V	11.00000 V

mA Input	1st point	2nd point
Faixa única	0.0000 mA	20.0000 mA

Input adjustment for Ω is performed in two steps:

a) Application of mV signal:

For the adjustment below, leave terminals RTD3(+) and RTD4(+) short-circuited

mV Signal	Terminals	1st point	2nd point
V_OHM3	RTD3(+) and GND IN (-)	90.000 mV	120.000 mV
V_OHM4	RTD4(+) and GND IN (-)	90.000 mV	120.000 mV

b) Application of Standard Resistors:

Connect a decade-box or standard resistors on terminals RTD1, RTD2, RTD3 and RTD4 (4-wire connection).

resistors	1st point	2nd point
OHM3	20.000 Ω	50.000 Ω
OHM2	100.000 Ω	500.000 Ω
OHM1	500.000 Ω	2200.000 Ω

CJC Adjustment

Measure the temperature of input terminal GND IN and store only the 1st point.

Cold Junction	1st point
CJC	32.03 °C

3.2. Output adjustment (OUT)

The output adjustment (except for CJC and Probe) is performed in STEPS. For each STEP the calibrator outputs a signal of the same type selected which must be measured and stored.

It is also possible to make a simple verification in the last two STEPS of each selected range, further details will be given below.

1) V, mV and mA.

For these output ranges, the display shows three information fields.

STEP 1 (1)	88.7% (2)
11.82813 (3)	

Field (1) is the current step. To go to the next step, press **↑** and to go backwards, press **↓**. In each step, the calibrator outputs the signal automatically.

Field (2) is the intimal value measured by the calibrator, expressed in percentage (%) of the range. Before storing the adjustment values, one should wait a few seconds for output signal stabilization.

Field (3) is the value entered by the user. After output signal measurement, press "ENTER" followed by the value measured and "ENTER" again.

The adjustment of these ranges comprises 5 steps. In steps STEP1 to STEP3, the signals are output and should be measured and stored, by pressing "ENTER". In steps STEP4 and STEP5, signals are output only for verification purpose and no values are stored. The verification points are listed in the table below.

	STEP 4	STEP 5
V	0.00000 V	11.00000 V
mV	0.0000 mV	110.0000 mV
mA	0.0000 mA	11.0000 mA

2) OHM

Due to accuracy reasons, the resistance output must be adjusted using 4-wire resistance reading method see figure 5 (H). Initially, the polarity of the wires is not important as the excitation current can flow in one or the other direction - from RTD1 to RTD2 terminal or from RTD2 to RTD1 terminal.

The adjustment should be performed for both ranges: 400 Ω and 2500 Ω .

STEP 1

This field shows the step of this range adjustment.

It consists of 6 steps. In steps STEP1 to STEP4, the signals are output and should be measured and stored, by pressing "ENTER". At transition from STEP3 to STEP4, the display shows "CHANGE CURRENT DIRECTION". At this time, exchange the banana plugs connected to RTD1 terminal with the ones connected to RTD2 terminal and

press “ENTER”. After that the adjustment continues. Steps 5 and 6 output signals are only for verification purpose and no values are stored.

	STEP 9	STEP 10
400 Ω	0.00 Ω	400.00 Ω
2500 Ω	0.0 Ω	2500.0 Ω

Probe adjustment

Firstly identify the connector pins for **Probe** input according to the figure below.

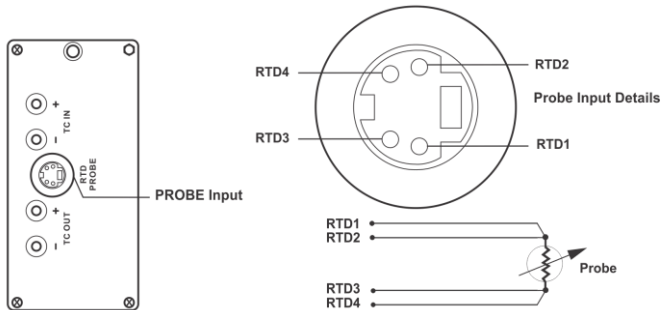

Fig. 17 - PROBE input connector

The **PROBE** adjustment is performed in two steps:

49

a) Application of mV signal:

mV Signal	Terminals	Bornes	1 st point	2 nd point
V_2	RTD2(+)*	GND OUT (-)	100.000mV	120.000 mV
V_1	RTD2(+)*	GND OUT (-)	120.000mV	600.00 mV

(*) RTD2, for **PROBE** adjustment, refers to the drawing shown above.

b) Application of standard resistors:

Connect a decade box or standard resistor to the probe connector, at positions RTD1, RTD2, RTD3 and RTD4, as shown above.

resistors	1 st point	2 nd point
R_2	20.000 Ω	50.000 Ω
R_1	100.000 Ω	500.000 Ω

CJC adjustment

The adjustment of the cold junction related to the thermocouple output is similar to the one related to the thermocouple input, but the temperature should be taken at the GND OUT terminal.

4 - Maintenance

4.1. Battery pack replacement

To have access to the battery pack of the calibrator, do as follows:

- 1) Remove the support;
- 2) Remove the four screws of the left side panel;
- 3) Pull the battery pack outwards (see figure 18);
- 4) Disconnect the connector;
- 5) Connect the new battery pack.

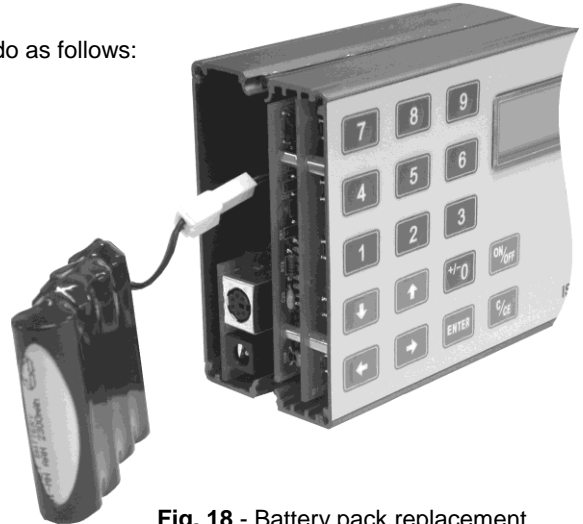

Fig. 18 - Battery pack replacement

4.2. Input current fuse substitution

To have access to the current fuse of the calibrator, do as follows:

- 1) Remove the support;
- 2) Remove the four screws of the left side panel and the four screws of the right side panel;
- 3) It is not necessary to open the instrument 180 degrees. Open according to the **figure 19** and locate the fuse;
- 4) Remove the fuse;
- 5) Place the spare fuse. There is a spare fuse in the carrying case of the calibrator.



Fig. 19 - Input current fuse substitution

Notes

- Adjusting procedures for this calibrator must be performed under the reference conditions of temperature and humidity.
- Better calibration results are achieved if warm-up time is at least two hours and if the battery charger remains disconnected from the calibrator since one hour before its usage.
- The standards used to adjust this calibrator should have an accuracy at least 3 times better than the accuracy values provided in this manual.

