

PRESYS

| Instruments



PC-507 Pressure Calibrator TECHNICAL MANUAL

Important Instructions:

- Keep PC-507 calibrator in a dry environment whenever possible.
- The fuse which protects the current measurement circuit, code 01.02.0277-21, is a special part. So, only replace the fuse by another original from factory.
- In case of failure, always send the instrument to the factory for repair.
- When not in daily use, before starting up, let the calibrator turned on for at least one hour.

TABLE OF CONTENTS:

| | |
|--|----|
| 1 - Introduction | 4 |
| 1.1. General Description | 4 |
| 1.2. Specifications | 5 |
| 1.3. Order Code | 7 |
| 2 - Operation | 10 |
| 2.1. Parts Identification | 10 |
| 2.2. Battery and Charger | 13 |
| 2.3. Using PC-507: Basic Functions | 13 |
| 2.4. Measurement or Input Functions | 18 |
| 2.5. Generation or Output Functions | 23 |
| 2.6. Available Power Supply (TPS) | 25 |
| 2.7. Application Examples | 25 |
| a) 4-wire Transmitter Calibration | 26 |
| b) 2-wire Transmitter Calibration | 27 |
| c) Current Supply | 27 |
| d) 2-wire Transmitter Simulation (XTR) | 28 |
| e) I/V Converter (Isolated) | 28 |
| f) 2-wire Pressure Transmitter Calibration | 29 |
| g) Supplying Transmitters with HART® Communication | 30 |
| h) P/V Converter Calibration | 32 |
| i) I/P Converter Calibration | 33 |
| j) Pressure Switches | 33 |

| | |
|--|----|
| 2.8. Special Programming..... | 35 |
| 2.8.1. FILTER Programming | 35 |
| 2.8.2. DECIMAL Programming..... | 35 |
| 2.8.3. SPEED Programming | 36 |
| 2.8.4. STEP Programming | 36 |
| 2.8.5. RAMP Programming | 37 |
| 2.9. Special Functions..... | 38 |
| 2.9.1. SCALE Function (IN)..... | 38 |
| 2.9.2. CAL Function | 40 |
| 2.9.3. SCALE Function (OUT)..... | 42 |
| 2.9.4. CONV Function..... | 44 |
| 2.10. MEM Command | 46 |
| 2.11. PC-507 Warning Messages | 47 |
| 3 – Calibration and Maintenance | 48 |
| 3.1. Input Calibration | 49 |
| 3.2. Output Calibration | 54 |
| 3.3. Installation of a New Sensor | 55 |
| 3.4. Adjustment of Electrical Signals for Pressure | 58 |
| 3.5. Replacement of Current Input Fuse | 62 |
| 4 – Unit Conversion..... | 63 |
| Notes:..... | 64 |

1 - Introduction

1.1. General Description

PC-507 pressure calibrator is an instrument of reduced dimensions, compact, operates with rechargeable battery and includes a practical carrying case to make easier its field use. Its technical features indicate performance levels comparable only to laboratory standards, it presents accuracy of 0.025% of full scale and can be provided with one, two, three or four pressure sensors, i.e., one calibrator may contain different ranges such as vacuum, 0 to 100psi, 0 to 1000psi and 0 to 3000psi, or any other possible combination among the available ranges. The calibrator may be purchased with a certain number of sensors, which may be later increased. Designed for field use, it contains useful items as carrying case, holders with fastener rings or belts for a hands-free operation, a high contrast OLED for a better viewing in poor lighting conditions, besides presenting measured and generated signals with large digits so that they can be seen far away. It includes rechargeable battery, and a high-size memory intended to store values obtained for a later upload to a computer, when applicable. Moreover, various other constructive features aggregate quality and efficiency to PC-507, allowing also its field and workbench use.

It incorporates the most modern concepts of calibration via computer, where data are shared between instrument and computer, improving efficiency in handling information through report and certificate issues, automatic work management, data organization and storage, for an overall coverage of quality procedure requirements, especially those related to ISO 9000.

When connected to a computer it can be used for real-time data acquisition.

1.2. Specifications

- Inputs

| Input Ranges | | Resolution | Accuracy | Remarks |
|--------------|------------------|------------|-----------------|---------------------------------------|
| volt | -10 V to 11 V | 0.0001 V | $\pm 0.02\%$ FS | $R_{\text{input}} > 1\text{ M}\Omega$ |
| | 11 V to 45 V | 0.0001 V | $\pm 0.02\%$ FS | |
| mA | -5 mA to 24.5 mA | 0.0001 mA | $\pm 0.02\%$ FS | $R_{\text{input}} < 160\ \Omega$ |

- Outputs

| Output Ranges | | Resolution | Accuracy | Remarks |
|--|------------|------------|-----------------|-----------------------------------|
| volt | -1 to 11 V | 0.0001 V | $\pm 0.02\%$ FS | $R_{\text{output}} < 0.3\ \Omega$ |
| mA | 0 to 22 mA | 0.0001 mA | $\pm 0.02\%$ FS | $R_{\text{max}} = 700\ \Omega$ |
| 2-Wire Transmitter (XTR) 4 to 22 mA | | 0.0001 mA | $\pm 0.02\%$ FS | $V_{\text{max}} = 60\text{ V}$ |

- Probe

| Probe Range | Resolution | Accuracy* | Remarks |
|---|----------------------|--|-----------|
| Pt-100 -200 °C to 850 °C / -328 °F to 562 °F | 0.01 °C / 0.01 °F | $\pm 0.1\text{ °C}$ $\pm 0.2\text{ °F}$ | IEC-60751 |

(*) The accuracy is related only to PC-507 input.

- Pressure Inputs

| Ranges * | Resolution | Accuracy** | Remarks |
|--------------------------------|------------|------------|--|
| (0) 0 – 250 mmH ₂ O | 0.001 | ± 0.05 % | Gage pressure. Used with air or inert gases. |
| (1) 0 – 1 psi | 0.0001 | ± 0.05 % | |
| (2) 0 – 5 psi | 0.0001 | ± 0.025 % | |
| (3) 0 – 15 psi | 0.0001 | ± 0.025 % | Gage or absolute pressure. Used with fluids (gases or liquids) compatible with 316 L stainless steel. |
| (4) 0 – 30 psi | 0.0001 | ± 0.025 % | |
| (5) 0 – 100 psi | 0.001 | ± 0.025 % | |
| (6) 0 – 250 psi | 0.001 | ± 0.025 % | |
| (7) 0 – 500 psi | 0.01 | ± 0.025 % | |
| (8) 0 – 1,000 psi | 0.01 | ± 0.025 % | |
| (9) 0 – 3,000 psi | 0.01 | ± 0.025 % | |
| (10) 0 – 5,000 psi | 0.1 | ± 0.025 % | |
| (11) 0 – 10,000 psi | 0.1 | ± 0.05 % | |
| (12) Other, upon request | | | |

(*) Gage pressure, vacuum (only for range 3), absolute or compound (from range 3 to 8).

(**) Full Scale percentage.

Accuracy values are valid within one year and ambient temperature of 20 to 26 °C. Outside these limits add 0.005 % FS / °C, using 23 °C as the reference temperature.

1.3. Order Code

Order Code

PC-507

Number of inputs

- 1 - one sensor
- 2 - two sensors
- 3 - three sensors
- 4 - four sensors

RANGE

(See table above)

Pressure Type Input 1

- A - Absolute (Only for ranges 3 to 8)
- G - Gage
- V - Vacuum (Only for range 3)
- C - Compound* (Only for ranges 3 to 8)
- D - Differential

RANGE Input 2** (Only for version with two sensors or more)

Pressure Type Input 2**

RANGE Input 3** (Only for version with three sensors or more)

Pressure Type Input 3**

RANGE Input 4** (Only for version with four sensors)

Pressure Type Input 4**

(*) From -15 psi to the full scale of the range

(**) Same code as input 1.

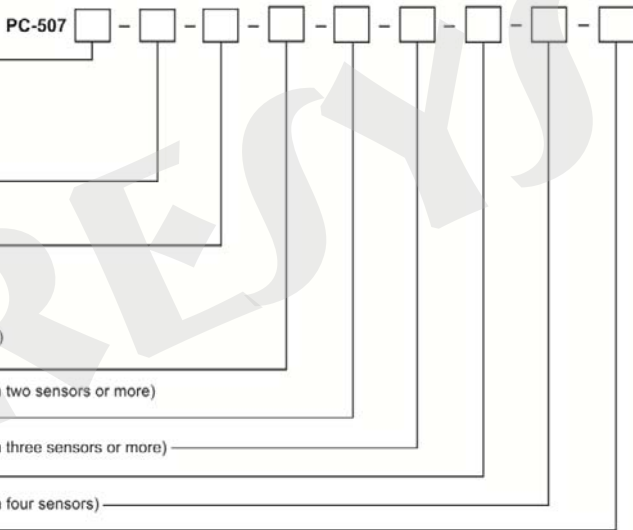

Special Software Functions

- Any output programmable in:

- 1) **STEP:** 10%, 20%, 25% or up to 11 programmable set-points via keyboard or adjustable time.
- 2) **RAMP:** up and down ramps with programmable travel and dwell time.

-Special Functions:

- 1) **SCALE:** makes the scaling of both input and output in 6 digits with signal and allows the configuration of decimal.
- 2) **CAL:** scales any input in the same unit of output.
- 3) **CONV:** converts any input into any output.

- **Mem Command:** It can store up to 8 types of configuration chosen by the user.

Transmitter power supply: 23Vdc, 30mA, regulated.

Warm-up time: 30 minutes.

Compensated temperature range: 0 to 45°C (32 to 113°F).

Operating ambient: 0 to 50°C and 90% maximum relative humidity.

Pneumatic connection: 1/4" NPTF (1/8" only for the range 0 - 10,000 psi).

Overpressure: up to twice the sensor full scale pressure (to sensors up to 5,000 psi).

Engineering units: psi, atm, kgf/cm², inH₂O, mH₂O, cmH₂O, mmH₂O, inHg, cmHg, mmHg, bar, mbar, Pa, kPa, MPa and torr.

Battery operation:

- 27 hours (nominal).

- 6 hours (when generating mA or using 2-wire transmitter power supply - TPS).

Serial Communication: Modbus[®] RTU Protocol (RS-232 / RS-485).

Items included: carrying case, test probes, manual (QR code), PC-507 stand – Order code: 02.06.0096-20, and battery charger.

Optional Calibration Certificate.

Dimensions: 90 mm x 144 mm x 72 mm (HxWxD).

Weight: 1.0 kg approx.

Warranty: 1 year, except for rechargeable battery.

Notes:

1 - PC-507 and ISOPLAN are Presys trademarks.

2 - Changes can be introduced in the instrument, altering specifications in this manual.

2 - Operation

2.1. Parts Identification

Front Panel

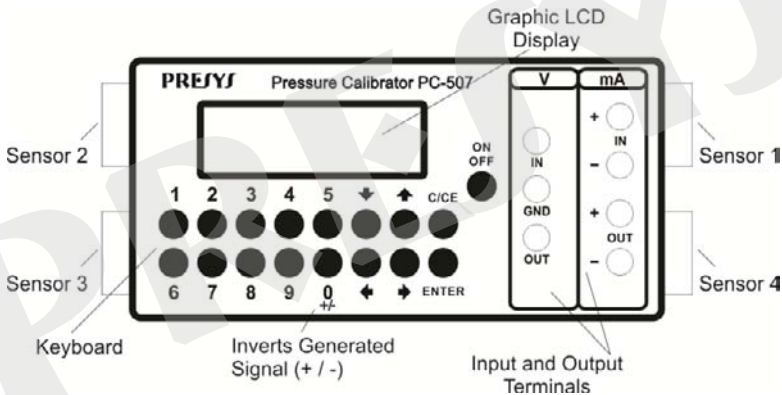
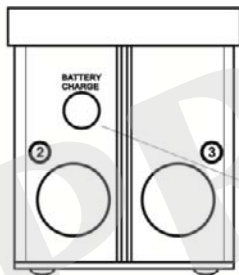

Fig. 01 – Front Panel

Left side-view Panel



Right side-view Panel

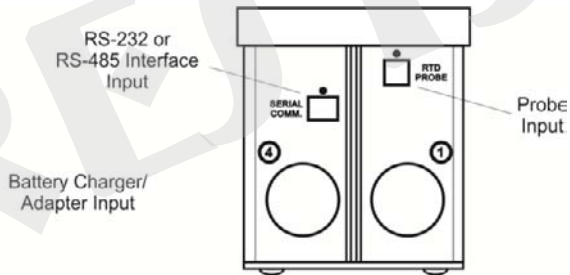

Fig. 02 – Side Panels

Ways of Use the Carrying Case

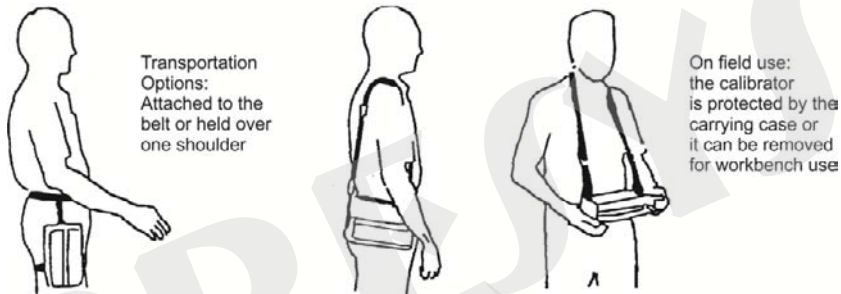

Fig. 03 – Ways of Use the Carrying Case

Accessories: The carrying case has two compartments, one is used to accommodate the calibrator and the other is used to keep several accessories such as test leads, spare fuse, handles for transport and field use and the technical manual.

Optional Items: Probe for temperature measurement, RS-232 or RS-485 interface, and ISOPLAN calibration software. The optional items are described in specific manuals.

2.2. Battery and Charger

PC-507 is supplied with rechargeable battery which enables up to 27 hours of continuous use, or less, especially when the 4-20 mA output or the 24Vdc power supply for transmitters is used. A charger is provided, which can be connected to 110 or 220 Vac. Time required for a full charge is 14 hours. When the display indicates **LOW BAT**, it is necessary to recharge the battery, which will continue in operation for a few minutes. The charger provides the battery charge while it powers the calibrator, allowing the calibrator to be used while the battery is being charged.

The batteries used by PC-507 are made of Nickel-Metal Hydride (Ni - MH). This new technology for rechargeable batteries does not have the undesirable characteristics of memory effect and environmental pollution as their preceding batteries made of Nickel Cadmium (Ni-Cd).

2.3. Using PC-507: Basic Functions

When the calibrator is powered on, the display shows:



⇒ OFF

ON

If the user does not select ON and press ENTER within 12 s, the instrument will turn itself off. The purpose is to save battery from turning the instrument on accidentally while in the bag.

When **ON** is confirmed, the calibrator goes through a self-test routine and shows the last calibration date and the value of the battery voltage; in case of failure, it displays a message to indicate RAM error or E2PROM error; if that occurs, the instrument should be sent for repair. The battery voltage is constantly monitored and the low battery warning is provided. After the self-test, the display shows the starting menu:

| | | | |
|---|-------------|------------|-------------|
| ⇒ | IN | OUT | EXEC |
| | CONF | CAL | COM |

IN / OUT - selects the input/ output functions.

CAL - selects functions for the calibrator adjustment. Do not enter in **CAL** option before reading the warning in section 3 - Calibration.

COM - refers to the communication with the computer, described in an appropriate manual.

EXEC - used to activate an input or output option which has been previously selected.

CONF – shows the sub-menu:

| | | | | |
|---|-----------|------------|---------------|-----------|
| ⇒ | CF | PRG | MEM | OF |
| | FN | BT | OLED P | DT |

CF changes both input and output temperature units from °C to °F and vice-versa. It allows choosing the temperature scale between IPTS-68 and ITS-90. It follows the encoding scheme described below:

°C-90 ITS-90 temperature scale in Celsius degrees.

°F-68 IPTS-68 temperature scale in Fahrenheit degrees.

OF - PC-507 incorporates energy saving resources (battery) through the automatic power off option (auto-OFF). This option has the following sub-menu:

| | | |
|---|--------------|--------------|
| ⇒ | NO | 5MIN |
| | 15MIN | 30MIN |

When **NO** is selected, the energy saving option is disabled.

If **5**, **15** or **30 min** is selected, PC-507 will turn off automatically after this period if the keyboard is not used.

BT shows the value of the battery voltage since the battery charger/adaptor is disconnected. When connected, **BT** shows the voltage level that is provided by PC-507 charger/ adaptor.

| Battery Level | Battery State | Display |
|---------------|---------------|--------------------|
| 4.0 to 7.0 V | normal | ----- |
| <4.0 V | low | LOW BATTERY |

OLED performs the setting of the display contrast using the arrow keys **▲** and **▼**. The last selection is saved by pressing the ENTER key.

P - Shows the sub-menu:

| | | |
|---|---------------|----------------|
| ⇒ | UNITIN | UNITOUT |
| | P1 | P2 |
| | | PARAM. |

P1 and **P2** - associates one pressure sensor (C1, C2, C3 or C4) to the mnemonic P1 or P2. Then, reading of the pressure sensor associated to P1 or P2 is performed after being enabled through **IN** or **OUT** menu.

UNITIN and **UNITOUT** - contain lists of all pressure engineering units which can be shown in a measurement by PC-507. **UNITIN** defines the unit of the pressure value shown in the upper line of the display (pressure chosen through **IN** option of main menu) and **UNITOUT** is related to the pressure value shown in the lower line of the display (chosen in **OUT**). Note that the units are distributed in several lines. In order to move the cursor through the units use the keys: **▼**, **▲**, **◀** and **▶**. After selecting the unit, press ENTER.

The available units are written below between parentheses beside the corresponding mnemonics presented in PC-507 display:

| | | | | | |
|------------|----------------------|------------|---------------------|------------|------------------------|
| PSI | (psi) | ATM | (atm) | KG | (kgf/cm ²) |
| INW | (inH ₂ O) | MW | (mH ₂ O) | CMW | (cmH ₂ O) |
| MMW | (mmH ₂ O) | INH | (inHg) | CMH | (cmHg) |
| MMH | (mmHg) | BAR | (bar) | MBA | (mbar) |
| KPA | (kPa) | TOR | (torr) | PA | (Pa) |
| MPA | (MPa) | | | | |

PARAM - configures the calibration parameters of the pressure sensors provided by the manufacturer. Refer to section 3.3 on Installation of a new sensor.

DT - updates the date and time for PC-507. Thus, when PC-507 performs a calibration within the COMMUNICATION option, calibration data is recorded together with their date and time of occurrence.

Whenever PC-507 is turned off, the date and time are not updated any longer. Thus, if you want them to be recorded with the calibration, you should update them. Use the vertical arrow keys **▲** and **▼** to change the value which is blinking and the horizontal arrow keys **◀** and **▶** to go to another value. The ENTER key confirms the last selection.

PRG, FN and **MEM** are special features of PC-507 described in other sections below.

2.4. Measurement or Input Functions

Select the type of signal to be measured by using the menus and use the corresponding terminals:

a) **IN** Selects the input functions:

| | | |
|-----------------|-----------|--------------|
| ⇒ V | mA | PROBE |
| Pressure | SW | NO |

Press ENTER to select volt measurement; press ↓, ↑, ← and → to select another signal.

IN = x.xxxx V

C/CE

Display indicates volt input in large digits.
Returns to the previous menu.

For the other signals follow the same selection process.
The **NO** option disables the input function.

b) Input or Measurement Connections

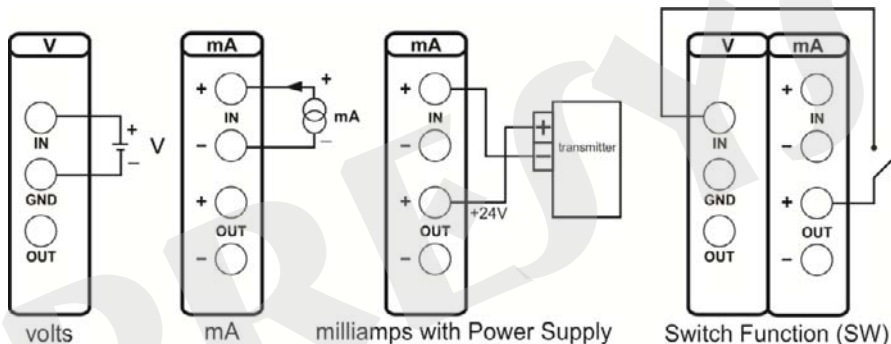

Fig. 04 – Input Connections

The contact input (**SW**) is used to measure the continuity of an external contact connected to PC-507 V IN and mA OUT (+) terminals. When there is continuity the input indicates **CLOSED**; otherwise, **OPEN** is indicated.

c) Probe Connection

Probe is an input for temperature measurement with an optional 4-wire Pt-100 probe. When using the Probe, temperature ranging from $-200.00\text{ }^{\circ}\text{C}$ to $850.00\text{ }^{\circ}\text{C}$ can be measured with high accuracy.

When Probe input sensor breaking occurs, the display shows the burn-out warning identified by the symbol illustrated below:

PROB = ????.?? °C

Connect the probe to PC-507 so that polarity identifications (white mark) match. See figure below:

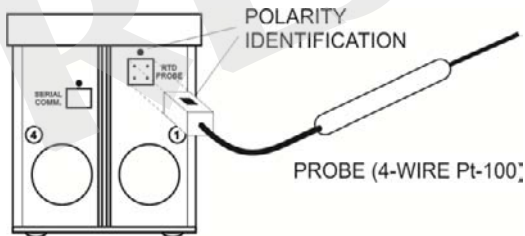

Fig. 05 – Probe Connection

d) Pressure Connection

Pressure option is related to pressure measurements. After its selection the display shows:



P1 and P2 correspond to the indication of pressure from two of the sensors chosen by the user from the **P** option in **CONF** menu (see item 2.3. Using PC-507: Basic Functions) and P1-P2 is related to the difference between pressure 1 and 2. Select any of these three options and press ENTER to enable the selected pressure.

After selecting the pressure indication, the user may also change in the **Pressure** option the associated pressure sensor (C1, C2, C3 or C4) and then the pressure engineering unit (previously configured for the **P1**, **P2** and **UNITIN** options in the **P** sub-menu of the **CONF** menu). The pressure sensor options are shown only for the P1 and P2 indications. For P1-P2, the calibrator uses the sensors configured in the **CONF** menu. If no change is needed, the user can simply press ENTER to confirm the choice of pressure sensor and unit or press **C/CE** to perform the measurements immediately.

Warning: Before each pressure measurement, it is necessary to keep the sensor open to air and set the pressure indication to zero. Use the arrow key ← to set pressures read by the input (IN option) to zero and the arrow key → to set pressures read by the output (OUT option) to zero.

Whenever the input signal (IN) is under or over the input ranges established in item 1.2. - Specifications, the display will show **UNDER** or **OVER**, respectively.

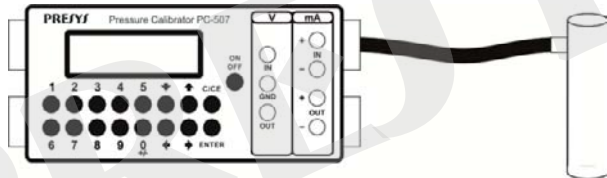

Fig. 06 – Pressure Measurement

2.5. Generation or Output Functions

Select through the menus the signal type to be generated and use the corresponding terminals

a) **OUT** Selects the output functions.

| | | |
|-----------------|-----------|--------------|
| ⇒ V | mA | PROBE |
| Pressure | NO | |

Press ENTER to select voltage generation. Press ↓, ↑, ← and → to select another signal.

OUT = x.xxxx V Display indicates the value of the output in volts in large digits. The sign can be inverted with the key **0 (+ / -)**

C/CE Returns to the previous menu.

For the other signals follow the same selection process.
The **NO** option disables the output function.

When selecting the pressure indication in the **Pressure** option, the user may also change the associated pressure sensor (C1, C2, C3 or C4) and pressure engineering

unit, previously configured for the **P1**, **P2** and **UNITOUT** options in the **P** sub-menu of the **CONF** menu, in the same way described in item 2.4. - Measurement or Input Functions.

b) Output or Generation Connections

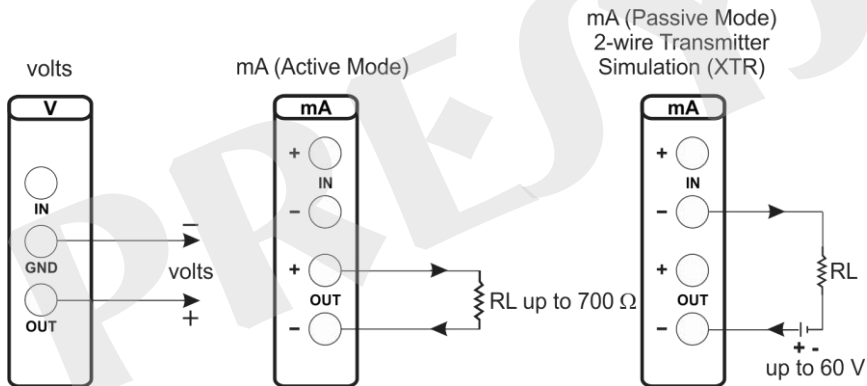

Fig. 07 – Output Connections

2.6. Available Power Supply (TPS)

PC-507 has a +23 Vdc regulated power supply (TPS), with short-circuit protection (current limited to 30mA).

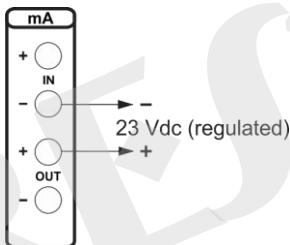

Fig. 08 – Power Supply

2.7. Application Examples

Despite its capability of showing simultaneously input and output functions in the display, there is no isolation between PC-507 V and mA input and output signals. This means that when PC-507 is connected to a converter (I / V, V / I, I / I or V / V) it may not work properly or the set could be damaged, in case the converter is not

galvanically isolated. Therefore, when using PC-507 input and output connected to a converter, it is important to make sure the converter is isolated (independent grounds).

a) 4-wire Transmitter Calibration

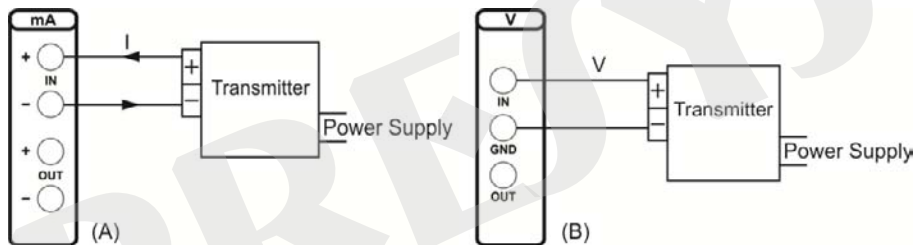
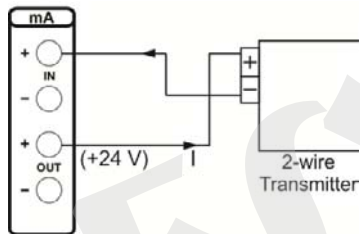
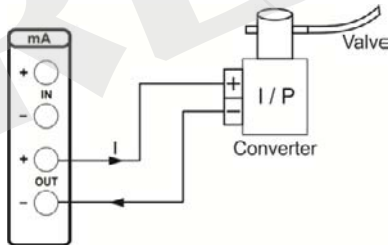

Fig. 09 – 4-wire Transmitter Calibration

b) 2-wire Transmitter Calibration**Fig. 10 – 2-wire Transmitter Calibration****c) Current Supply****Fig. 11 – Current Supply**

d) 2-wire Transmitter Simulation (XTR)

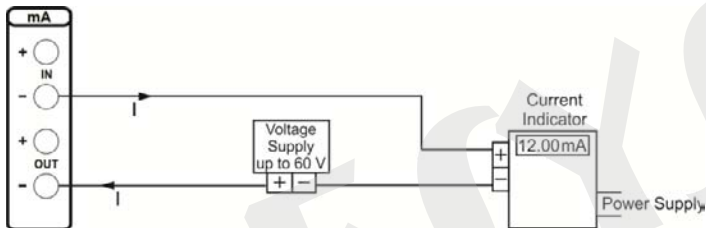

Fig. 12 – 2-wire Transmitter Simulation

e) I/V Converter (Isolated)

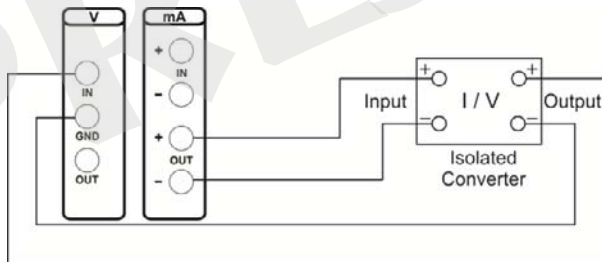

Fig. 13 – I/V Converted (Isolated)

f) 2-wire Pressure Transmitter Calibration

Use the 23Vdc power supply from PC-507 (TPS) to power a 2-wire transmitter and make the connection of current as follows.

Select **mA** (current) from the input menu of PC-507 and **Pressure** from the output menu. Input current readings can be scaled to pressure unit through the special function **CAL** (see item 2.9.2 - CAL Function on Special Functions). In this way, the deviation between the input and the output of the pressure transmitter can be easily calculated.

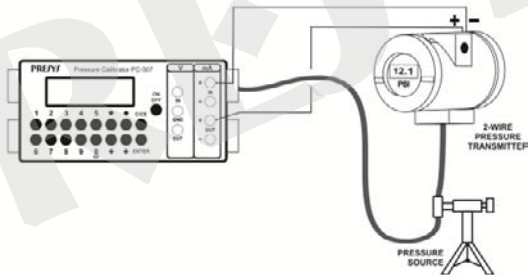

Fig. 14 – 2-wire Pressure Transmitter Calibration

g) Supplying Transmitters with HART[®] Communication

The PC-507 TPS purpose is to provide power supply for 2-wire transmitters. When a 2-wire transmitter communicates with a hand held using HART[®] protocol, it usually requires a 250 Ω load resistance connected in series with the PC-507.

The figure below shows the PC-507 TPS reading current and powering a transmitter with HART[®] communication.

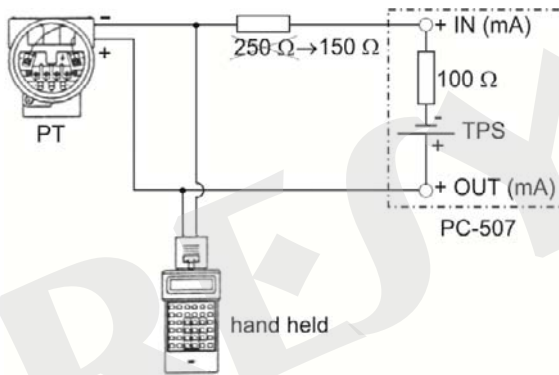

Fig. 15 – Supplying Transmitters with HART[®] Protocol

If the communication between hand held and transmitter fails, verify if the power supply is sufficient to the transmitter.

If not, it is recommended to decrease the 250 Ω resistor to 150 Ω, because 100 Ω is the PC-507 input impedance. Thus, the transmitter receives higher supply voltage to start working normally with the hand held.

h) P/V Converter Calibration.

Connect the pressure transmitter output to the PC-507 volt (**V**) input as shown below.

Select **V** (volts) from the input menu of PC-507 and **Pressure** from the output menu. In order to scale the input reading to pressure unit, see item 2.9.2 - **CAL** Function (Special Functions).

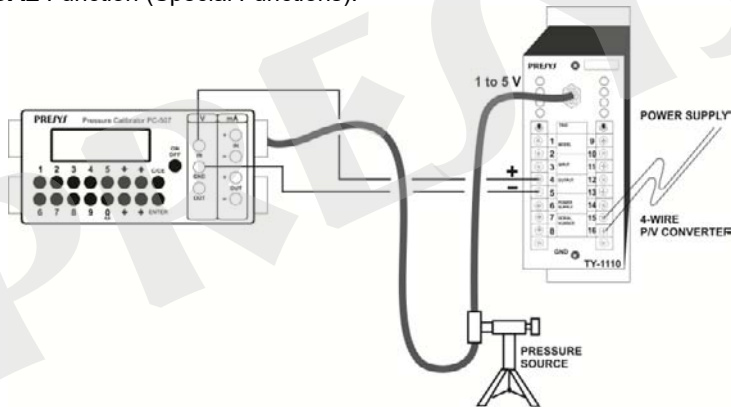

Fig. 16 – P/V Converter Calibration

i) I/P Converter Calibration.

I/P converters are easily adjusted with PC-507 by using the connections shown below. Select **Pressure** from the input menu of PC-507 and **mA** (current) from the output menu.

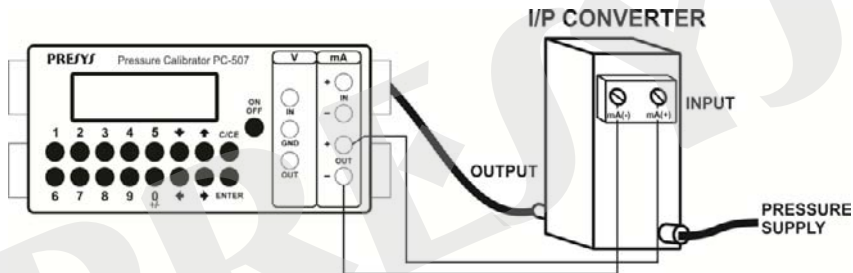

Fig. 17 – I/P Converter Calibration

j) Pressure Switches

Pressure switches are devices that receive a pressure signal and have relay alarm. The relay is activated whenever input pressure reaches a certain alarm setpoint.

Connect the pressure switch relay output to the contact input of PC-507, V IN and mA OUT (+) terminals, and make the pneumatic connections illustrated in the

figure below. Select **SW** (switch) from the input menu of PC-507 and **Pressure** from the output menu.

Vary the pressure manually. The contact input will track the output pressure reading until the relay position changes. At this time, the relay input reading will 'freeze' with the **LOCK** message in the upper line of the display. The value next to the **LOCK** message is the pressure switch alarm setpoint.

To unlock the input, press the arrow key ←.

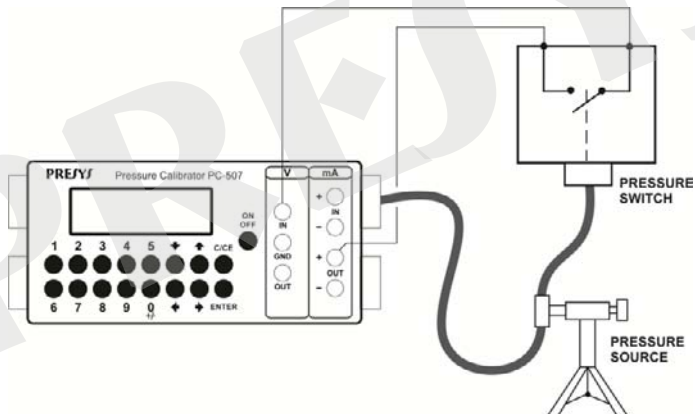

Fig. 18 – Pressure Switches

2.8. Special Programming

When **PRG** is selected, the display shows:



This option allows the selection of special programming features for **INPUT** or **OUTPUT**. **INPUT** is provided with **FILTER**, **DECIMAL** and **SPEED** options. **OUTPUT** is provided with **STEP** and **RAMP** options. The **NO** option disables the special programming.

2.8.1. FILTER Programming

The value of this parameter (in seconds) configures the time constant of a first order digital filter coupled with the selected input. When the filtering of the measured signal is not required, just set this parameter as **0** (zero).

2.8.2. DECIMAL Programming

The value of this parameter (**0**, **1**, **2**, **3** or **DEFAULT**) indicates the number of decimals that the value measured at the input will be displayed.

Note: **DEFAULT** corresponds to the maximum decimals that PC-507 may display in an input measurement, in accordance with its resolution.

2.8.3. SPEED Programming

This program lets you modify the conversion rate of the input pressure. By selecting **YES**, the conversion rate becomes twice as fast as without this option.

2.8.4. STEP Programming

The **STEP** programming makes PC-507 output vary in pre-defined steps. It is useful in calibrations where certain scale points are verified, e.g., 0% - 25% - 50% - 75% - 100%.

To enable this programming, select an output then back to the main menu by pressing **C/CE**, select **CONF** (ENTER), **PRG** (ENTER), **OUTPUT** (ENTER) and **STEP** (ENTER). After this sequence, there will have the options **10%**, **20%**, **25%** and **VARIABLE**; these options define the percentage of variation at the output for each step. The **VARIABLE** option allows the programming of the setpoint values for each step, up to a maximum of eleven values.

The output type must be previously configured; otherwise the **SELECT OUTPUT FIRST** message will be displayed. In this case, press **C/CE** to go back to the main menu and select the output type.

After completing the selection of the step variation percentage, the start and the end values of the range within which the output will vary (**Setpoint High and Low**) are requested.

To continue, go back to the main menu and activate **EXEC**, the output now performs the **STEP** programming, always starting from the beginning of the range,

and the arrow keys **▲** or **▼** must be pressed when you want to proceed to the following output steps.

By pressing the arrow key **▶**, each step will be reached automatically after a preset time, which is defined through the keys: **1** (10s), **2** (20s), **3** (30s), **4** (40s), **5** (50s), **6** (60s), **7** (70s), **8** (80s) and **9** (90s). These time steps are only enabled once the arrow key **▶** has been pressed, what changes the STEP mnemonic to 0s. Under this situation, the steps are automatically and continuously scanned. To quit this mode (STEP set by time), just press the arrow key **▶**.

2.8.5. RAMP Programming

By using this programming, PC-507 output varies automatically, thus producing ramps and level marks which can be programmed to work once or continuously.

From the main menu, select **CONF** (ENTER), **PRG** (ENTER), **OUTPUT** (ENTER) and **RAMP** (ENTER). Then you must enter the start and the end values of the range within which the output will vary (**Setpoint High** and **Low**), and also the value of time (in seconds) required for a complete ramp within the range (**Ramp Time**). Another value that may be configured is how long it should dwell at the level mark (**Dwell Time**), i.e., the time during which the output remains constant between two ramps.

After the configuration is completed, go back to the main menu and press **EXEC**; then the output goes to the starting value of the configured range. When the arrow key **▲** is pressed, an ascending cycle starts, and by pressing **▼**, a descending cycle begins, only once. Pressing **▲** and **▼**, the cycles are repeated continuously.

2.9. Special Functions

Selecting **FN** the display shows:



With these options, you may select special functions related to the **INPUT** or the **OUTPUT**.

INPUT has the **SCALE**, **CAL** and **NO** options.

The input type must be previously configured; otherwise the **SELECT INPUT FIRST** message will be displayed. In this case, press **C/CE** to go back to the main menu and select the input type.

2.9.1. SCALE Function (IN)

It establishes a linear relationship between PC-507 input signal and what is shown on the display, according to the graphic below.

The scaled display indication (#) may represent any engineering unit, such as m/s, m³/s, % etc.

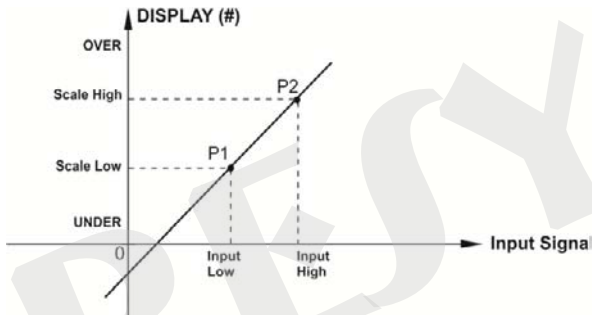

Fig. 19 –SCALE Function (LINEAR)

The number of decimals (up to 4) shown on the display may be configured by using **Scale Dec** parameter.

The value for **Input High** must be necessarily higher than **Input Low**. On the other hand, **Scale High** and **Scale Low** may have any relationship between themselves: higher than, lower than or equal to, and they may have a signal before them. Thus direct or reverse relationships may be established.

For the current input, a linear relationship may be established as it has been previously shown or it may be squared (**FLOW**) as illustrated below:

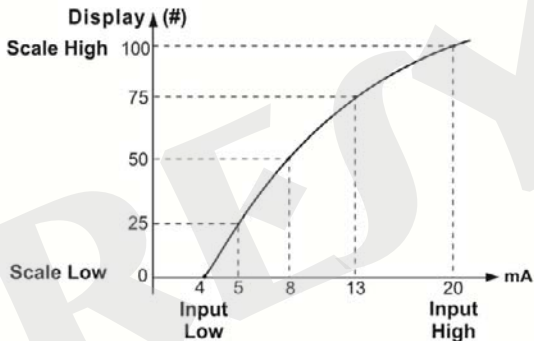

Fig. 20 – SCALE Function (FLOW)

2.9.2. CAL Function

PC-507 may be used to calibrate or check current converters. In a typical application, it would “generate” a pressure signal and measure the current signal from a pressure transmitter. Due to reasons of quickness and easiness to compare

errors at the input and output of the converter, the reading of PC-507 current input can be displayed in the same unit of the generated signal, i.e., pressure unit. Thus, both readings of PC-507 input and output are scaled in pressure unit, and the error can be promptly calculated. To activate this PC-507 function, just fill the four parameters shown in the graphic below. To access these parameters press ENTER after **CAL** is indicated on the display.

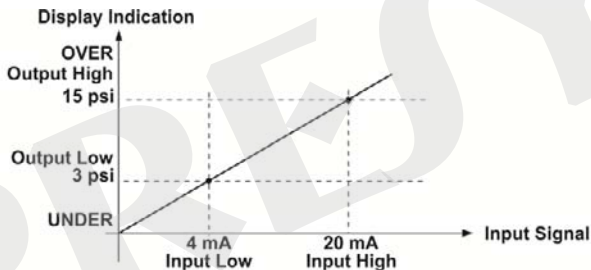

Fig. 21 – CAL Function (LINEAR)

Note that when **CAL** function is active, the display will indicate **CAL** instead of **IN**, as illustrated below:

CAL = 12.1000 psi
OUT = 12.0000 psi

To disable **SCALE** or **CAL** functions, just select **NO** option from the menu below and press ENTER.



OUTPUT has the **SCALE**, **CONV** and **NO** options, described as follows.

The output type must be previously configured; otherwise the **SELECT OUTPUT FIRST** message will be displayed. In this case, press **C/CE** to go back to the main menu and select the output type.

2.9.3. SCALE Function (OUT)

Scale function of PC-507 output allows it to simulate the operation of a transmitter. Transmitter input is made directly by keyboard, and it can generate voltage or current as output signal.

SCALE output function relates to the output signal generated by PC-507 to the value shown on display, according to the example shown below.

The scaled display indication (#) may represent any engineering unit, such as m/s, m³/s, % etc.

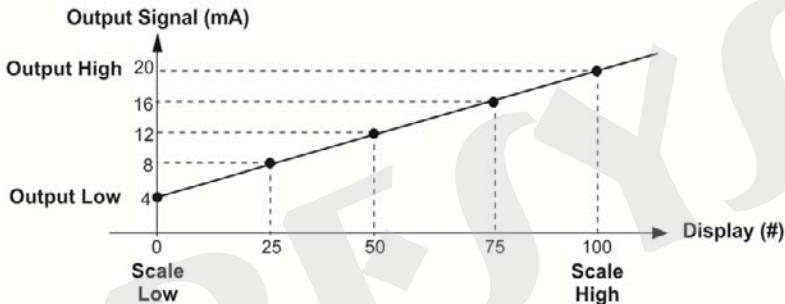

Fig. 22 – SCALE Function (LINEAR)

Scale Dec parameter configures the decimals presented on the display.

The value of **Output High** must always be higher than **Output Low**. **Scale Low** and **Scale High** parameters may have any relationship between them, provided that they are different. Thus, direct or reverse relationships may be established.

In case of current output, as well as for the input, a linear or squared (FLOW) relationship may be established, as shown below.

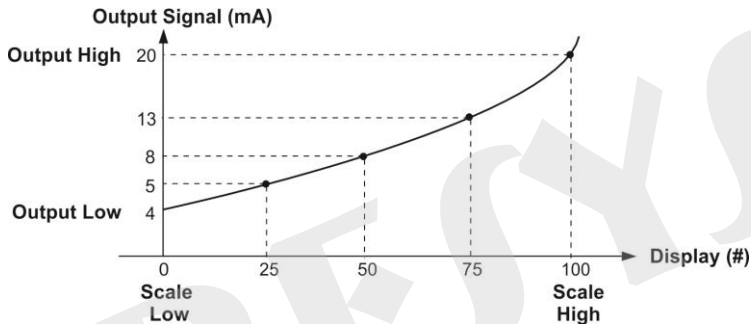

Fig. 23 – SCALE Function (FLOW)

2.9.4. CONV Function

By using the **CONV** function, PC-507 may convert any input signal into mA or V output signal. It may therefore work as a non-isolated converter.

Once PC-507 input and output have been selected, you must fill in the four parameters shown in the next figure. To access these parameters press ENTER after **CONV** is shown on the display.

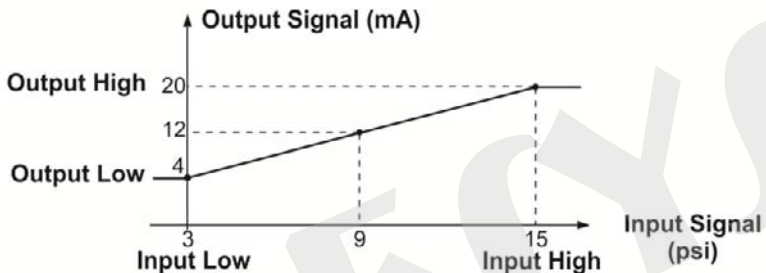

Fig. 24 – CONV Function

The value of **Output High** must always be higher than **Output Low**. **Input High** and **Input Low** parameters must never be equal. Thus, any type of direct or reverse retransmission from input to output can be obtained.

Scale and **Conv** functions may be disabled by selecting the **NO** option and pressing ENTER, as shown below:

SCALE CONV ⇒ NO

2.10. MEM Command

PC-507 calibrator offers several programming and special functions that can be often used. In this case, storing these configurations in the calibrator saves time. One can have up to eight sequences stored in memory.

After making a specific operation in PC-507 through the keyboard, return to the menu **CONF**. Select **MEM** and press ENTER. The display will show:

| | | |
|---|------------------|---------------|
| ⇒ | WRITE | RECALL |
| | CLEAR ALL | |

Select **WRITE** and press ENTER. The display will show:

| | | | | |
|---|----------|----------|----------|----------|
| ⇒ | 1 | 2 | 3 | 4 |
| | 5 | 6 | 7 | 8 |

The numbers shown above represent eight memory positions. Select any of them and press ENTER. PC-507 preset configuration is stored in the chosen memory. In order to call it back, even though PC-507 has been turned off and on, select **RECALL** (ENTER) and the memory number that stored the previous configuration. Press ENTER.

Any new configuration can be written over an already used memory location.

When you want to clear all eight memory locations, select **CLEAR ALL** and press ENTER.

2.11. PC-507 Warning Messages

| Warning | Meaning | Procedure |
|-------------------------------------|---|--|
| RAM ERROR READ MANUAL | Problem in RAM memory | Turn PC-507 off and on. If the error persists, contact Presys technical assistance |
| EEPROM ERROR READ MANUAL | Problem in EEPROM memory | Same as the previous item |
| CHK LOOP | mA output opened | Check the connections |
| LOW BATTERY | Level of battery voltage is low | Connect the charger to the PC-507 |
| UNDER / OVER | Input signal out of specifications or scaling range | See item 1.2, on Input Specifications |
| LOW RES | Short-circuit in V output | Check the circuit connected to PC-507 impedance |
| ????.?°C | Temperature sensor is open | Check probe connector polarity |

3 – Calibration and Maintenance



ATTENTION: To prevent potential damage to the instrument's calibration due to improper adjustments, the access password must be requested from your local distributor.

Adjustment procedure access password: To perform input or output adjustments, the owner of the calibrator must contact the local distributor, providing the equipment's **serial number** to receive the password that allows access to the adjustment.

WARNING: Enter the following options only after understanding them completely. Otherwise, it may be necessary to return the instrument to the factory for recalibration!

Select **CAL** option from the main menu and press ENTER. Enter the **PASSWORD** to access the calibration menu.

The password works as a protection to calibration ranges. After entering the password, the menu displays the options:

| | | |
|------|-----|------|
| ⇒ IN | OUT | DATE |
|------|-----|------|

Then, choose if the calibration will be performed over an input range (**IN**) or an output range (**OUT**). **DATE** is an option which allows you to record the date in which the calibration is performed and once it has been filled in, it will be displayed every time the instrument is turned on. The date can only be updated after a calibration (adjustment) operation.

Options for **IN** calibration are:

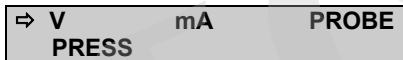

Options for **OUT** calibration are:

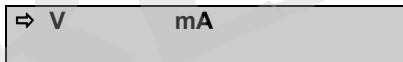

There is no order or interdependence between the calibrations.

3.1. Input Calibration

Select the corresponding mnemonic and apply the signals presented in the tables below.

When calibrating inputs, the display shows on the 2nd line the value measured by PC-507 and on the 1st line the same value is expressed as a percentage.

Note that the applied signals just need to be close to the values shown in the table.

Once the signal has been applied, store the values of the 1st and 2nd calibration points by pressing keys 1 (1st point) and 2 (2nd point).

| V Input | 1st point | 2nd point |
|----------------|-----------------------------|-----------------------------|
| Single range | 0.00000 V | 11.00000 V |

| mA Input | 1st point | 2nd point |
|-----------------|-----------------------------|-----------------------------|
| Single range | 0.0000 mA | 20.0000 mA |

Probe Calibration.

First identify the connector pins of **Probe** input according to the figure below:

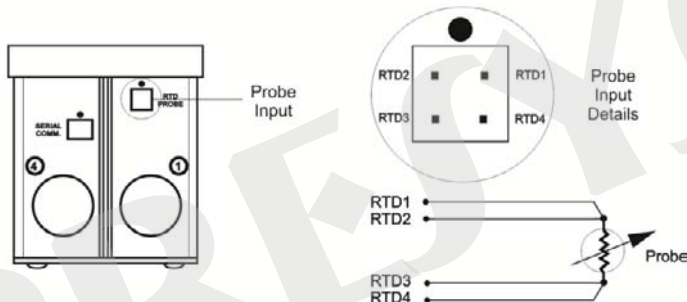

Fig. 25 – Probe Calibration

Probe calibration is performed in two steps:

a) mV Signal Application:

| mV signal | Terminals | | 1 st point | 2 nd point |
|-----------|-----------|-----------|-----------------------|-----------------------|
| V_2 | RTD2(+) | V GND (-) | 100.000 mV | 120.000 mV |
| V_1 | RTD2(+) | V GND (-) | 120.000 mV | 600.000 mV |

b) Resistance Application:

Connect a decade box or standard resistors to the **Probe** connector, at positions RTD1, RTD2, RTD3 and RTD4, as shown above.

| Resistors | 1 st point | 2 nd point |
|-----------|-----------------------|-----------------------|
| R_2 | 20.000 Ω | 50.000 Ω |
| R_1 | 100.000 Ω | 500.000 Ω |

Pressure Calibration

By selecting **Press** (ENTER), it shows the sub-menu:

| | |
|-------|-----|
| ⇒ V_1 | V_2 |
| P1 | P2 |

Pressure input calibration is only completed after calibrating the options: **V_1**, **V_2**, **P1** and **P2**. Note that **P1** and **P2** refer to two pressure sensors chosen from **P** option in **CONF** menu

V_1 and **V_2** calibration is explained in section 3.4

The calibrations of the sensors associated to mnemonics **P1** and **P2** consist of the application of two pressure values close to zero and full scale (FS) of the pressure sensor. Store the values of the 1st and 2nd calibration points by means of keys 1 (1st point) and 2 (2nd point).

Gage, Absolute or Differential Pressure Calibration

| Pressure Sensor | Applied Pressure | Stored Value |
|------------------------|--|--|
| 250 mmH ₂ O | 0.0000 mmH ₂ O 250.0000 mmH ₂ O | 0.000 mmH ₂ O (key 1) 250.000 mmH ₂ O (key 2) |
| 1 psi | 0.000 mmH ₂ O 703.070 mmH ₂ O | 0.00 mmH ₂ O (key 1) 703.07 mmH ₂ O (key 2) |
| 15 psi(*) | 0.00000 psi 15.00000 psi | 0.0000 psi (key 1) 15.0000 psi (key 2) |

(*) Other pressure ranges follow the same procedure by altering full scale from 15 psi to the full scale of the used sensor (unit in psi).

Vacuum Sensor

| Pressure Sensor | Applied Pressure | Stored Value |
|-----------------|---|---|
| Vacuum | 1.00000 psi (absolute) 13.00000 psi (absolute) | -12.5000 psi (key 1) -0.5000 psi (key 2) |

3.2. Output Calibration

Select the corresponding mnemonic, choose the setpoint explained as follows, measure the signal generated by PC-507 and store this value as detailed in the following tables.

For calibration of outputs, the display shows three values:

| |
|--|
| SP = 50.000% ⁽¹⁾ |
| 49.999 ⁽²⁾ 5.00000 ⁽³⁾ |

First Field (1) is the value of the setpoint as a percentage (%) of the output range required by the user and it is selected by pressing key "0" (zero).

Second Field (2) is the value measured by PC-507 expressed in percentage (%) of the output range. Before providing the 1st and 2nd calibration points, one must wait until this value stabilizes.

Third Field (3) is the value entered by the user after the output has been measured and the values corresponding to the two setpoints have been stored: 1st point (key 1) and 2nd point (key 2).

| V output | 1st point | 2nd point |
|-----------------|-----------------------------|-----------------------------|
| Single range | SP = 10.000% | SP = 80.000% |

| mA output | 1st point | 2nd point |
|------------------|-----------------------------|-----------------------------|
| Single range | SP = 10.000% | SP = 80.000% |

3.3. Installation of a New Sensor

In case the user purchases a new sensor, due to reasons as replacement of a damaged sensor by overpressure or even for expanding the range of used pressures, it is necessary to follow the procedure described below.

Remove PC-507 bottom cover, and take off the two screws on the sides. Disconnect the battery from the circuit.

Choose position 1, 2, 3 or 4 where the sensor will be installed. These positions correspond to electrical connectors CN1, CN2, CN3 and CN4, respectively. There are two possibilities:

- There is already an installed sensor: in this case disconnect it from the electrical connector and take off the two screws on the side panel which hold the sensor to PC-507 case.
- There is no sensor installed: remove the two jumpers installed at the electrical connectors, and the cover on the opening for the sensor in PC-507 side panel.

When handling a new sensor, take care not to apply any mechanical stress to the sensor, since it could damage the sensor permanently.

Introduce the sensor, tighten the screws which fix the sensor to PC-507 panel and connect the sensor to the corresponding connector observing the polarity white marks.

After the installation of the sensor, connect the battery to PC-507, considering the polarity identifications (white marks) and assemble the bottom cover with the two screws.

The sensors purchased individually are sent with the following data:

- Serial Number
- Pressure range **C**
- Correction parameters 1 to 9.

In order to configure these parameters access the menu **CONF** and confirm with ENTER.

| | | | |
|-----------|------------|-----------------|-----------|
| CF | PRG | MEM | OF |
| FN | BT | OLED ⇨ P | DT |

Select **P** and confirm:

| | |
|---------------|-------------------|
| UNITIN | UNITOUT |
| P1 | P2 ⇨PARAM. |

Select **PARAM** and confirm:

| |
|-------------------|
| PASSWORD |
| + 0000000. |

Introduce the password to continue:

| | | | |
|-------------|-----------|-----------|-----------|
| ⇨ C1 | C2 | C3 | C4 |
|-------------|-----------|-----------|-----------|

Look on PC-507 side panel the number related to the installed sensor 1, 2, 3 or 4 and select the corresponding sensor **C1**, **C2**, **C3** or **C4**.

| | | | | |
|-----|---|---|---|---|
| ⇒ 1 | 2 | 3 | 4 | 5 |
| 6 | 7 | 8 | 9 | C |

Select C and confirm:

| |
|---|
| SENSOR RANGE 00005.000 PSI |
|---|

Specify in parameter **C** the pressure range of the sensor and press ENTER.

Then, select mnemonic 1 and type on the keypad the number of the 1st parameter sent with the sensor:

| |
|--|
| PARAMETER 1 + 000.0000000 |
|--|

Press ENTER to confirm, and go to the next parameter. Proceed the same way as done for parameter 1.

After the configuration of the parameters **1** to **9**, go back to menu **IN** to verify the pressure indication of the new sensor installed. Altering any one of these parameters causes the change of the pressure calibration (parameters **P1** and **P2** from **PRESS** option) to default values.

Do not forget to configure the new sensor (**C1**, **C2**, **C3** or **C4**) for mnemonic **P1** or **P2** in the input selection menu.

3.4. Adjustment of Electrical Signals for Pressure

Pressure sensors are excited with fixed currents of 1.00000 mA providing a millivoltage for the pressure calibrator to measure. After several years of use, they may require another adjustment. In case the mentioned adjustments are not performed properly, the pressure measurements lose their accuracy. **Make sure to carry out the procedure described in this section only when strictly necessary.**

Remove the bottom cover from PC-507, taking the two side screws off. Disconnect the battery from the circuit. Identify the figure below with the bottom view of PC-507.

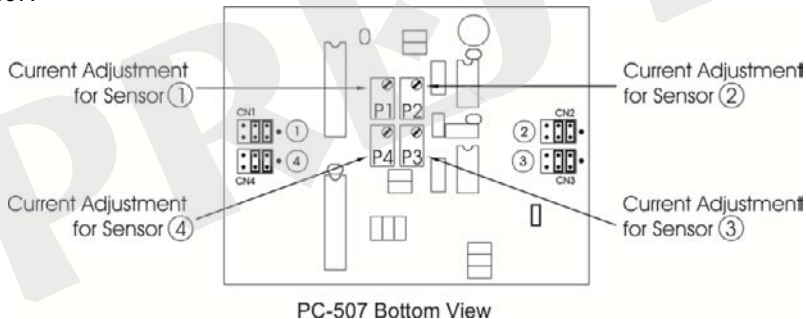

Fig. 26 – Adjustment of Electrical Signals for Pressure

a) Adjustment of Current Sources

Look for the female connector (with blue and white wires) provided together with PC-507 test leads, kept in the carrying case. To adjust the current corresponding to sensor 1, disconnect CN1 and place the female connector, making the two white marks to match (Fig. 27). Connect the battery to the circuit and turn PC-507 on.

Measure the current between the blue and white wires using a high precision ammeter. Adjust trimpot P1 until reaching a current with value:

1.000000 mA

In order to adjust the current source of sensor 2, note that the connector CN1 must be jumped according to the previous figure or the corresponding sensor should be installed. The same procedure is valid for positions CN3 and CN4.

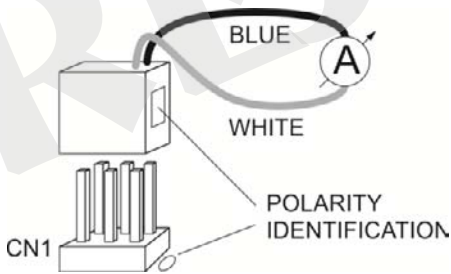

Fig. 27 – Excitation Current for Pressure Calibration

b) Adjustment of mV Input for Pressure Measurement

Use the female connector (with red and black wires) provided together with PC-507 test leads, kept in the carrying case. The mV adjustment is accomplished using only connector CN1 and is valid for all sensors. Connect to CN1 the connector according to the figure below and apply the mV signals corresponding to the table on the next page. Note that all the other three positions (CN2, CN3 and CN4) must be jumped (Fig. 26) or with the corresponding sensor installed.

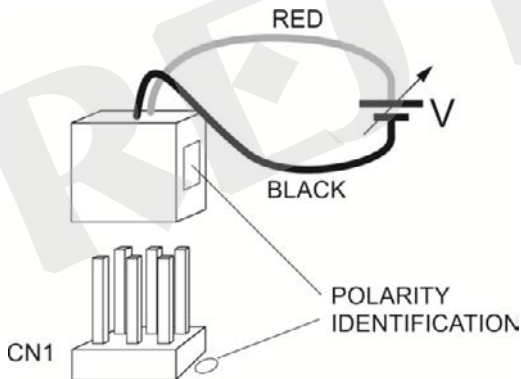

Fig. 28 – Adjustment of mV for Pressure Calibration

| mV Signal | 1st point | 2nd point |
|------------------|-----------------------------|-----------------------------|
| V_2 | 0.000 mV | 120.000 mV |
| V_1 | 100.000 mV | 250.000 mV |

The red wire goes to the (+) terminal of the mV source and the black wire to the (-) terminal.

Go to the pressure calibration menu of PC-507 to access the mnemonics **V_2** and **V_1**. Once the signal is applied, store the values of the 1st and 2nd calibration points through the keys 1 (1st point) and 2 (2nd point).

After completing these steps, connect again the sensor terminals to the respective connectors.

The bottom cover of PC-507 can be placed back using the two screws. Do not forget to check if the battery connector was plugged firmly in its terminal, before closing PC-507.

3.5. Replacement of Current Input Fuse

In order to have access to PC-507 fuse, proceed as follows:

- 1) Remove all two screws from the rear panel;
- 2) Remove all five screws from the fixing board;
- 3) Displace the internal part, attached to the front panel out of the box;
- 4) Identify the glass fuse as illustrated in the figure below;
- 5) Replace the damaged fuse by the spare fuse (PC-507 carrying case).

The fuse of PC-507 has special characteristics. Thus, use only the 32 mA fuse provided, code 01.02.0277-21.



Fig. 29 – Replacement of Current Input Fuse

4 – Unit Conversion

| psi | atm | kgf/cm ² | inH ₂ O ⁽¹⁾ | mH ₂ O ⁽¹⁾ | cmH ₂ O ⁽¹⁾ |
|-----|------------------------------|------------------------------|-----------------------------------|----------------------------------|-----------------------------------|
| 1 | 6.804605 $\times 10^{-2}$ | 7.030696 $\times 10^{-2}$ | 2.767990 $\times 10^1$ | 7.030696 $\times 10^{-1}$ | 7.030696 $\times 10^1$ |

| psi | mmH ₂ O ⁽¹⁾ | torr ⁽²⁾ | inHg ⁽²⁾ | cmHg ⁽²⁾ | mmHg ⁽²⁾ |
|-----|-----------------------------------|---------------------------|---------------------|---------------------|---------------------------|
| 1 | 7.030696 $\times 10^2$ | 5.171500 $\times 10^1$ | 2.036024 | 5.171500 | 5.171500 $\times 10^1$ |

| psi | bar | mbar | MPa | kPa | Pa |
|-----|------------------------------|---------------------------|------------------------------|----------|---------------------------|
| 1 | 6.894757 $\times 10^{-2}$ | 6.894757 $\times 10^1$ | 6.894757 $\times 10^{-3}$ | 6.894757 | 6.894757 $\times 10^3$ |

(1) For water at 4 °C (39.2 °F)

(2) For mercury at 0 °C (32 °F)

Notes:

- Recalibration of PC-507 must be performed under reference conditions of temperature and humidity.
- PC-507 power supply must be disconnected from the battery charger during recalibration.
- Calibration standards used during PC-507 recalibration must have accuracy at least 3 times better than the accuracy values provided in this manual.

PRESYS

PRESYS | Instruments Inc.
www.presys.com.br